



400 Series

English **EN**
Operators Manual



CE



To view, print or download
the latest manual, visit:

www.tennantco.com/manuals

www.greenmachines.com

YM036
Rev. 4 (5-2007)



This manual is furnished with each new model. It provides necessary operation and maintenance instructions.



Read this manual completely and understand the machine before operating or servicing it.

Read this manual completely and understand the machine before operating or servicing it.

This machine will provide excellent service. However, the best results will be obtained at minimum costs if:

- The machine is operated with reasonable care.
- The machine is maintained regularly - per the machine maintenance instructions provided.
- The machine is maintained with manufacturer supplied or equivalent parts.



PROTECT THE ENVIRONMENT

Please dispose of packaging materials, old machine components and fluids in an environmentally safe way according to local waste disposal regulations.



Always remember to recycle.

MACHINE DATA

Please fill out at time of installation for future reference.

Model No. - _____

Serial No. - _____

Installation Date - _____

Tennant UK Cleaning Solutions Ltd.

Bankside, Falkirk FK2 7XE
Scotland, United Kingdom
Phone: (+44) 1324- 611666
www.greenmachines.com

Tennant Company

PO Box 1452
Minneapolis, MN 55440
Phone: (800) 553- 8033 or (763) 513- 2850
www.tennantco.com

Specifications and parts are subject to change without notice.

Original Instructions, copyright © 2007 Tennant Company



Table of contents

Chapter 1 How to use this manual 3

Chapter 2 Getting to know your machine... 5

Chapter 3 Preparing for first use.

Setting the suction nozzle height..... 7

Fitting brushes and setting brush height 8

Fitting the trash sack 9

Chapter 4 Daily checklist 11

Chapter 5 Starting, stopping and driving.

Starting and stopping the engine..... 16

Setting the brush speed 17

Setting the engine speed..... 17

Driving and stopping..... 18

Braking and emergency brake release..... 19

Chapter 6 The water system.

Water controls and water jets..... 20

Water tank and disinfectants 22

Chapter 7 The wander hose.

Wander hose and blanking plate..... 23

Unblocking the wander hose 24

Chapter 8 Sweeping with your machine.

Sweeping in wet weather 25

Sweeping along buildings and curbs..... 25

Sweeping corners 26

Climbing and descending curbs 26

Transporting your machine..... 27

Objects to avoid when sweeping..... 28

Unblocking the suction nozzle..... 29

Chapter 9 414RS model only.

Extending and stowing the seat..... 29

Using the seat safely 31

Seat adjustments 32

Chapter 10 424TR and 424HS models only.

Fitting the seat 33

Adjusting the seat and footplate 34

Selecting high speed mode (424HS only) . 34

Raising and lowering the suction nozzle
(424HS only)..... 31

**Chapter 11 The Clean and Safe or Dog
Excrement Attachment option.**

Preparation and use 37

Chapter 12 Leaf sweeping and leaf bags. . 39

Chapter 13 The snowplow option.

Fitting and use 41

Chapter 14 Machine care and wash-down.

End of use wash-down 44

End of week wash-down..... 47

Care of filter bag 48

Chapter 15 Fault Finding 49

Chapter 16 General Specifications 59

Safety labels & graphical symbols 60

Machine chassis plate 64

Chapter 1

How to use this manual.

Please read the manual fully and follow all safety advice before using your machine.

Welcome to the Applied Sweepers Operator's Manual. We have written this manual to help you use your Green Machine correctly and above all, safely. Please read this manual fully before using your Green Machine.

⚡ Throughout this manual you will see areas where particular attention must be paid to avoid death, physical injury or damage to you or your machine. Please read these points carefully and follow the instructions.

Your Green Machine should have been supplied with the following:

Operator's Manual (This book).
Service Schedule
Parts Catalogue
Kubota Engine Manual
Warranty Card

If you need help, or if any of these are missing, please contact your local Green Machine distributor listed at the front of this book.

A shop manual containing detailed repair information suitable for use by mechanics and technicians is sold separately.



Important Safety Information

- ⚡ **Your Green Machine is a motorized item with moving parts. Incorrect use can lead to death or bodily injury and/or damage to your machine.**
- ⚡ **Always carry out the daily checks before using the machine.**
- ⚡ **Ensure that any defects are reported to a supervisor as soon as they are found.**
- ⚡ **Always switch the engine OFF when the machine is being refueled.**
- ⚡ **Always switch the engine OFF and remove the machine keys if you are leaving machine unattended.**
- ⚡ **Always switch the engine OFF before opening the machine top cover.**
- ⚡ **Always switch the engine OFF and remove machine keys before trying to clear a blockage.**
- ⚡ **Always be aware of your surroundings when sweeping.**
- ⚡ **Ensure that the machine has the correct level of maintenance in accordance with the manufacturers recommendations.**
- ⚡ **Never try to clear a blockage with the engine running or with the machine keys in the ignition.**
- ⚡ **Never leave the machine unattended with the engine running.**
- ⚡ **Never put hands, fingers, or loose clothing near moving parts.**
- ⚡ **Never open the radiator cap when the engine is hot.**
- ⚡ **Never run the engine with the front suction hose removed.**
- ⚡ **Never wash the machine with the engine running.**
- ⚡ **Do not run the engine in a confined or poorly ventilated space.**
- ⚡ **Never stand on the Ride on Seat when sweeping.**
- ⚡ **Never drive up or down curbs whilst seated.**
- ⚡ **Never make non-approved modifications or use the machine in any other way than that shown or demonstrated by an official representative of Applied Sweepers.**
- ⚡ **Your Green Machine incorporates Safety Inter-Lock switches on the Suction Fan Access Panel and on the Rear Trunking. If either of these items are opened or removed, the engine will be stopped and the engine starter will be isolated. However, prior to opening or removing these items, the engine should be switched OFF and the ignition keys removed.**

Chapter 2

Getting to know your Green Machine.

How the machine works

The Green Machine works by airflow. As long as airflow is maintained the machine should sweep correctly.

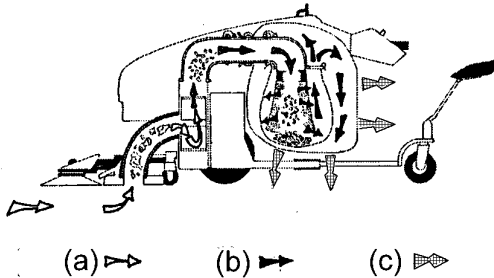

Two front brushes sweep any debris towards the center of the machine.

The debris is then picked up by the flow of air through the vacuum hose (a).

A powerful impeller fan not only creates the vacuum, but also mulches the debris as it passes through.

The impeller fan is very strong and robust. Broken glass or bottles which pass through the fan come out looking like rock salt with no sharp edges for you to cut yourself upon.

The air and mulched debris is next blown up through the back trunking (b).

A water spray jet inside the back trunking dampens the dust-laden debris down as it passes through.

The debris and air are then blown downwards

through a nylon filter screen that filters out the debris and collects the debris in a regular plastic trash bag.

The air escapes through the filter screen and is finally blown out through a special fabric filter bag that screens out any remaining dust.

As this air escapes, then the suction hose vacuums up more new air and debris.

The Green Machine is easy to drive. Simple hand controls allow you to vary the speed in forward and reverse, and there are automatic brakes.

A powerful and quiet diesel engine provides power not only for the impeller fan, but also for the hydraulic system that runs both the brushes and drive.

Depending on your model, you can either ride-behind or walk behind your Green Machine as you work.

The machines are equipped with lights, a beacon and a horn or voice warning message so that you may work safely among pedestrians or motor vehicles.

All in all, you will quickly learn that your machine saves a lot of time and physical labor when sweeping compared to pushing a broom.

We'll next look at identifying the major features of your Green Machine.



Your Green Machine incorporates Safety Inter-Lock switches on the Suction Fan Front Access Panel and on the Rear Trunking. If either of these items are opened or removed, the engine will be stopped and the engine starter will be isolated. However, prior to opening or removing these items, the engine should be switched OFF and the ignition keys removed.

Note in this manual left and right are described as if you are standing behind the handles looking forward.

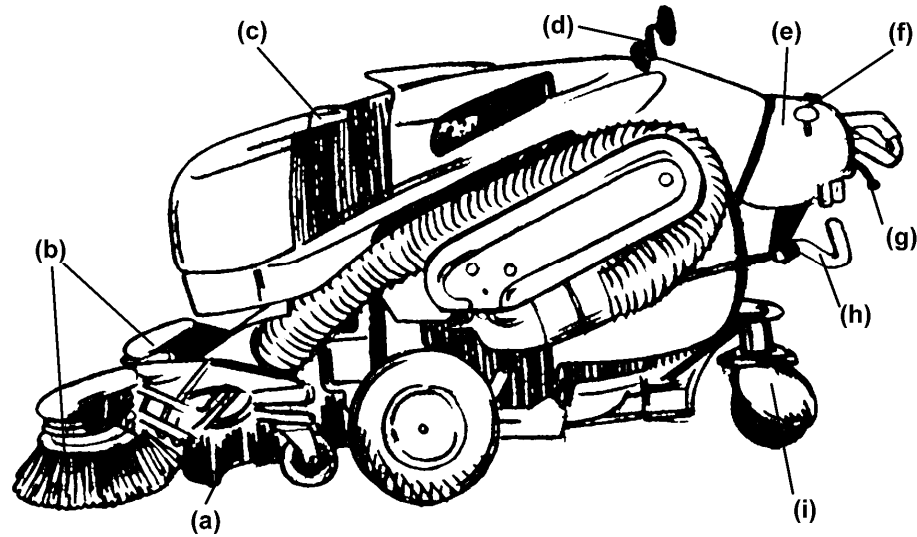

Left Side

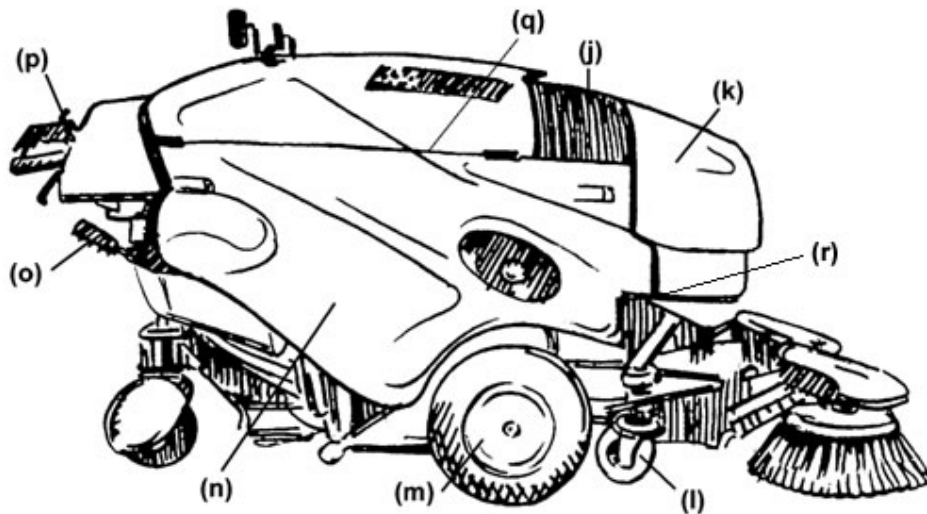

Right Side

(a) Suction Nozzle
 (b) Front Brushes
 (c) Flashing Beacon
 (d) Rear View Mirrors
 (e) Operator Console

(f) Cup Holder
 (g) Drive Lever
 (h) Wander Hose
 (i) Rear Wheel
 (j) Water Tank

(k) Front Storage Box
 (l) Front Castor Wheel
 (m) Main Road Wheel
 (n) Side Access Panel
 (o) Parking Brake

(p) Throttle, brush and flap controls.
 (q) Safety switch (under top cover)
 (r) Safety switch (on fan access panel)

Chapter 3

Preparing for your first use.

This chapter will guide you through the adjustments needed to optimize your Green Machine for its first use.

Setting the suction nozzle height.

It is important to check that the suction nozzle height is correctly set.

If the suction nozzle is too high off the ground, then suction performance will be reduced.

If the suction nozzle is too low to the ground, then the suction nozzle will make contact with uneven surfaces and the horseshoe-shaped skid underneath the suction nozzle will get worn down and will need to be replaced.

Always set height with machine on level ground. Remove the castor locking pins (one on each side).

It helps to move the wander hose to the side to allow access to the left-side locking pin.

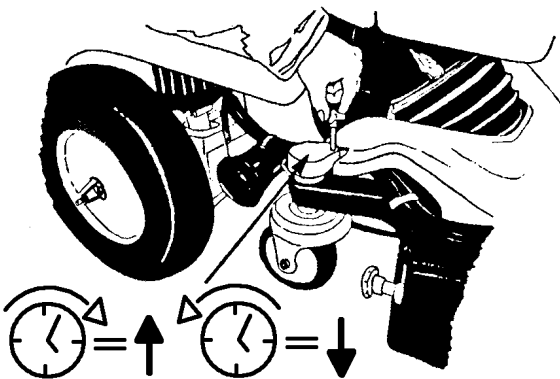

Adjust the nozzle to the correct height by

rotating the castor caps on each side. Turn the caps clockwise to raise the nozzle, or anti-clockwise to lower the nozzle.

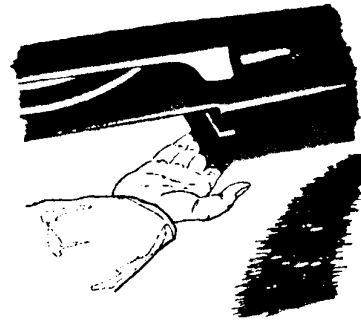

You should adjust both sides to leave just enough space for your fingers to fit between the horseshoe-shaped skid and the ground - about $\frac{3}{4}$ " (20mm) at each side is good.

If the surface that you are sweeping is very uneven, then you may wish to raise the nozzle a little more.

You will have to check and readjust the nozzle height from time to time. This is because the castor wheels that hold the suction nozzle off the ground will wear down as you use your machine. Failure to periodically check the nozzle height can mean expensive repairs if your front nozzle wears down.

Fitting the brushes.

Tilt the machine rearward to gain easier access to the front of the machine.

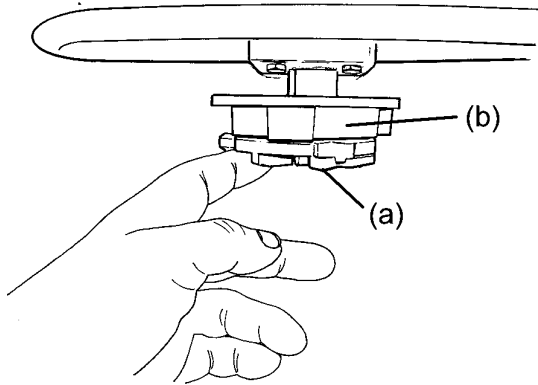

Turn the plastic locking cam (a) so that the lugs on the cam line up with the lugs on the metal drive hub (b).

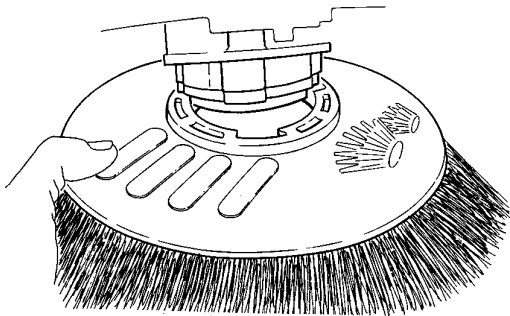

Fit the new brushes and turn the locking cam until you feel a solid click. This click means that the brushes are now in the fully locked position.

The cam on the left side of the machine locks in the opposite way to the cam on the right side. This is so that both cams are self-tightening when the brushes are turning.

Setting the brush height.

Always check the suction nozzle height is correct before adjusting the brush height.



Unhook the brush. Push down on the brush assembly until you feel the brush can move down no further.

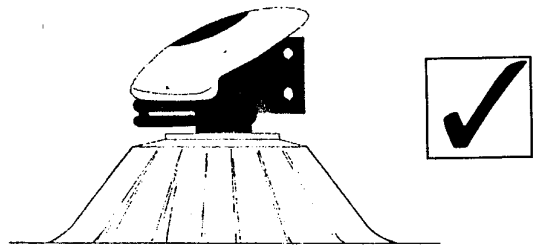

The correct brush height is when the tips of the brush bend slightly as shown.

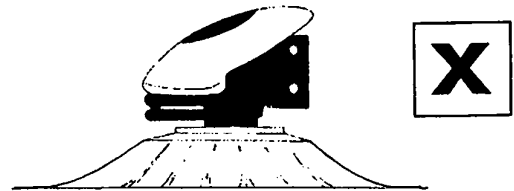

If when you push down, the brush spreads out too far then the brushes are set too low. This will not improve the quality of sweeping, but your brushes will wear out much faster.

As you use the machine and the brushes wear down, you will have to re-adjust the brush height from time to time.



Removing the protective plastic sheet.

Your Green Machine is often shipped with a protective plastic sheet fitted inside the back trunking that must be removed prior to first use.

- ⚡ First ensure you remove the ignition keys so that the machine will not start accidentally.
- ⚡ Never start the machine with the back trunking open.

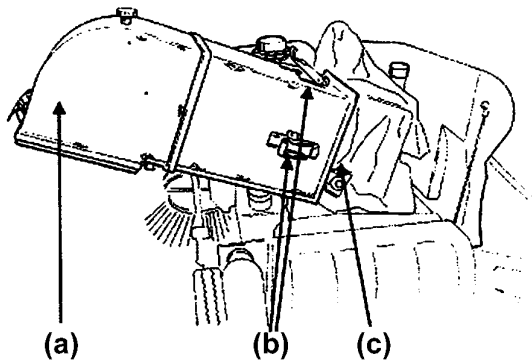

Undo the two toggle clamps (b) and swing out the back trunking (a).
Remove the protective plastic (c).
Close the back trunking by first lifting the hinge lock pin and then swinging the back trunking closed.
Re-fasten the toggle clamps.

Fitting the plastic trash sack.

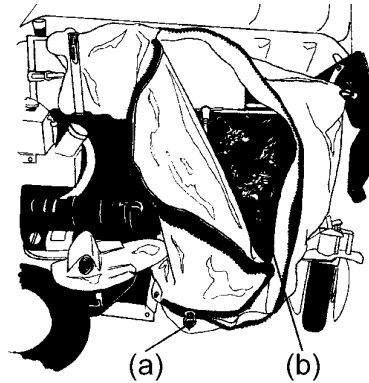

Open the zipper (a) on the filter bag (b).

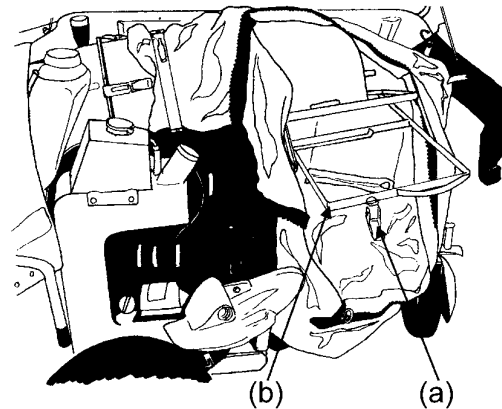

Un-fasten the toggle clamp (a) and pull out the sliding frame (b) towards you.



Remove the plastic screen and holder (a) and insert the screen inside a regular 30 gallon



(70 Litre) plastic trash sack.

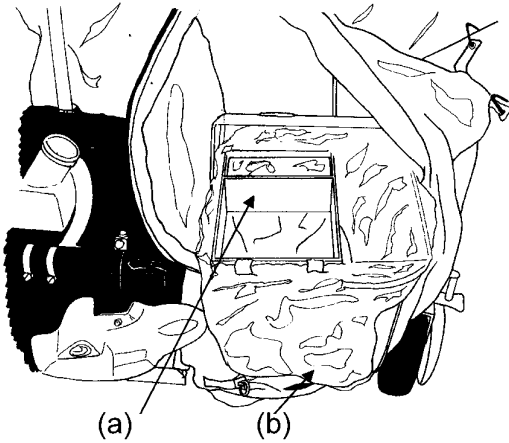

Now insert the plastic sack and screen back into the sliding frame.

Please make sure that the plastic sack edges are folded around the outer sliding frame, and not around the inside screen holder (a).

If you fit the plastic sack in the wrong way,

your machine will not pick up properly.
Close the sliding frame and refasten the toggle clamp.

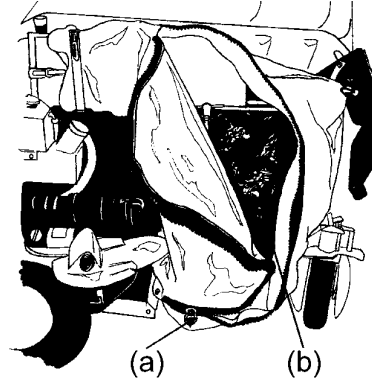

Zip up the filter bag and close the top cover.
Now you are ready to go to the next chapter – daily operator checks.



Chapter 4

Daily checklist.

These checks must be done daily before starting

Check the engine oil level.

Ensure that the engine oil level is between the minimum and maximum marks on the dipstick (a). Top up as required. Use regular motor oil – 10W40 grade is recommended.

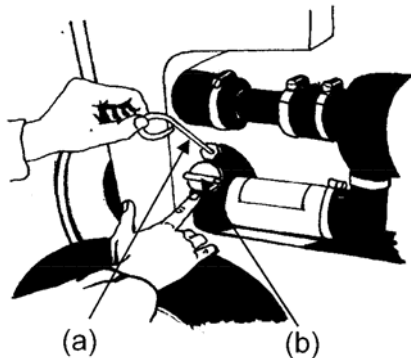

If you need to top-up the oil, you can do so through the filler cap (b) that is located just below the dipstick. Add a small quantity of oil at a time and recheck the level frequently. Take care not to overfill.

Check the water tank level.



Fill up the water tank with cold water by opening the red filler cap (a). You can see the water level in the tank using the clear plastic sight tube (b). You may wish to add a disinfectant to the water system. Please see Chapter 6 for more details.



Check the diesel fuel level.

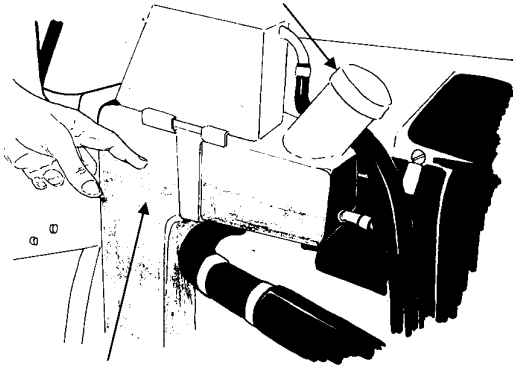

Top up the fuel tank with regular diesel fuel if required.

A full tank should last you about ten hours running time.

Be careful not to spill any fuel— if you do so then wipe off with a dry rag.

Avoid spilling diesel fuel on the air intake screen that is located beneath the air filter housing.

If fuel spills on it, then dirt will stick to the screen and may result in the engine starting to smoke after some time. (Please see Chapter 15 - Faultfinding).

Check the radiator coolant level.

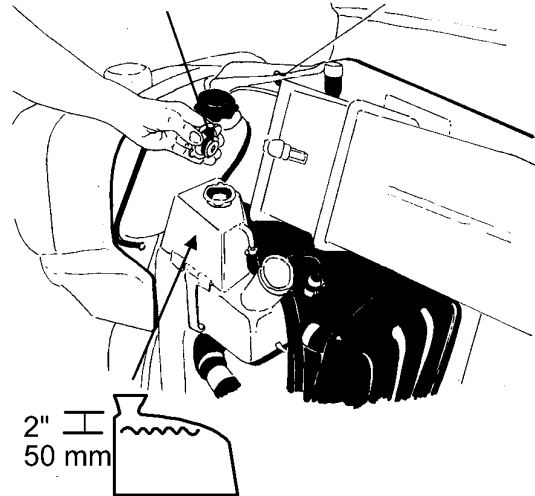

Open the radiator header tank pressure cap.

⚡ **Take care when opening the pressurized cap when the engine is hot. This is a pressurized system with very hot liquid inside.**

The level should be 2" (50 mm) below the top of the tank when the engine is cold.

Top up with a mixture of 50% water / 50% anti-freeze when necessary.

Do not overfill, or else excess coolant will escape out of the tank when the engine heats up!

Check all electrical Items.

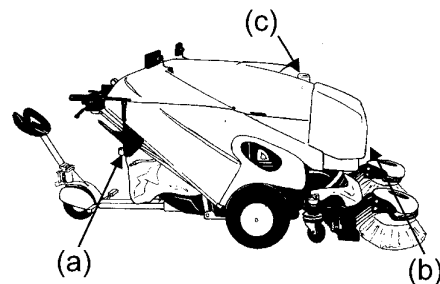

With the ignition key switched on to the first position, check that the lights (a) and (b),



the beacon (c) and beeper (or optional voice message) are all working correctly.

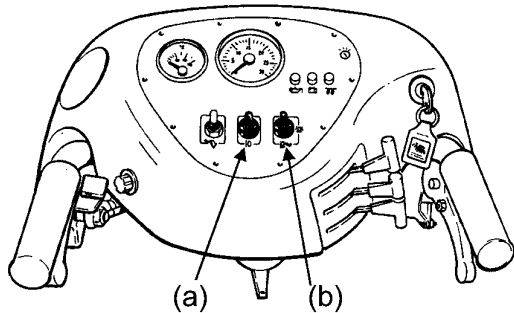

The switches are located on the control console as shown.

Switch (a) operates the lights.

Switch (b) is a two-position switch.

The first position operates the beacon only.

The second position operates both the beacon and the beeper or voice warning.

Your Green Machine incorporates Safety Inter-Lock switches on the Suction Fan Front Access Panel and on the Rear Trunking. If either of these items are opened or removed, the engine will be stopped and the engine starter will be Isolated.

However, Prior to opening or removing these items, the engine should be switched off and the ignition keys removed.

To check that these switches are functioning correctly, switch off the engine and swing open the Rear Trunking. **STANDING WELL CLEAR** of the open trunking, turn the ignition switch to the engine start position. The engine **SHOULD NOT CRANK**. If it does, report immediately to your supervisor. If the engine does not crank with the rear trunk open, then the safety switches are operating correctly.

Close the rear trunking. **NOTE:-** In spite of the fact that the machine is fitted with safety Inter-Lock switches, the engine should always be switched off and the ignition keys removed before opening the Suction Fan Front Access panel or the Rear Trunking.

Check the water sprays.

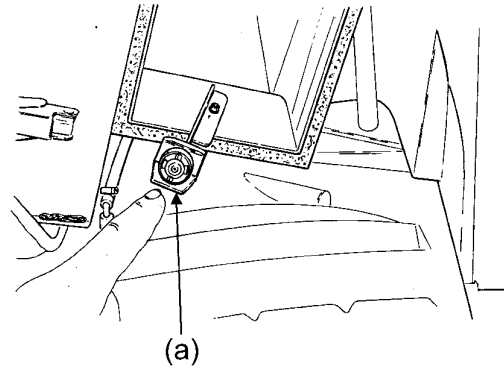

Check that the water spray jet in the back trunking is working – see Chapter 6 for more information.

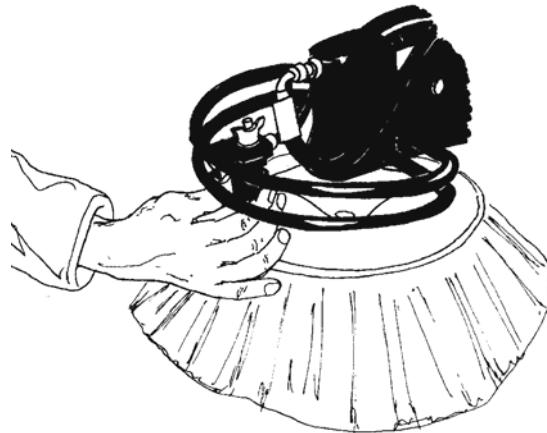

Check that the water spray jets for the brushes are working – see Chapter 6 for more information.

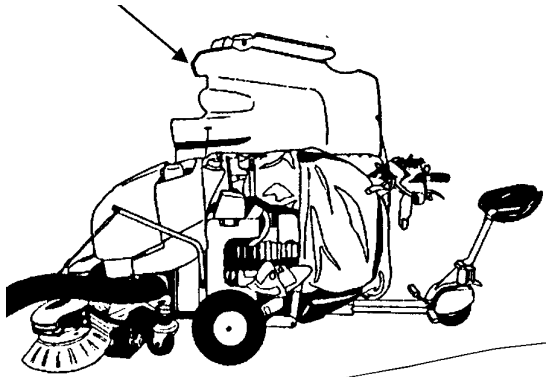

After all checks have been completed close the top cover, ensuring that it is correctly secured.

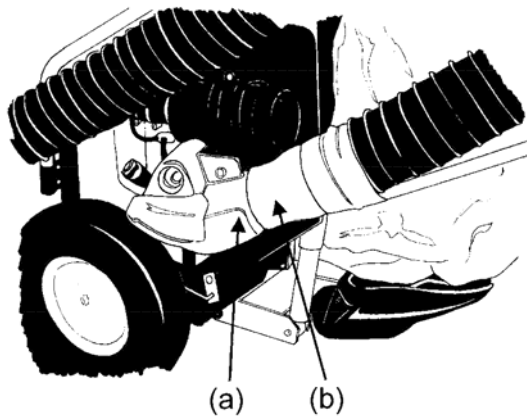

Replace the wander hose (b) correctly in its holster (a).

Daily Check Summary

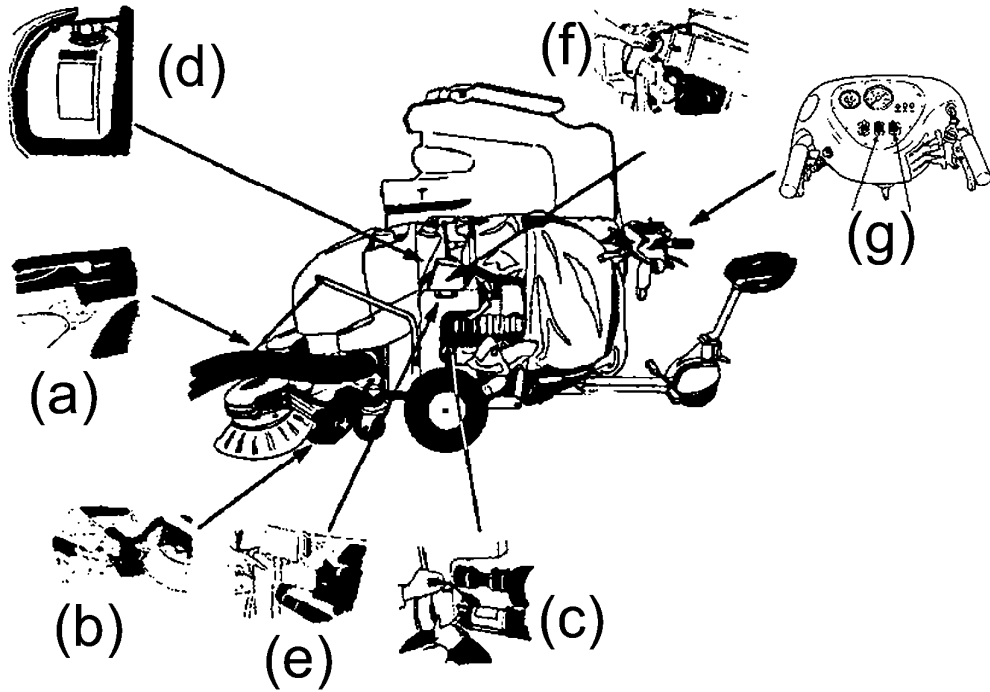

- Nozzle height correctly set.....(a)
- Brush Height correctly set.....(b)
- Correct engine oil level.(c)
- Water tank filled.(d)
- Diesel tank filled.....(e)
- Correct coolant level.(f)
- Check all electrical items working.(g)

Chapter 5

Starting, stopping and driving

Starting the engine.

- ⚡ Never start the engine if the front suction hose is removed or the back trunking is open.
- ⚡ Never run the engine continuously in a confined, or enclosed space.

Insert the starter key into the key-switch.

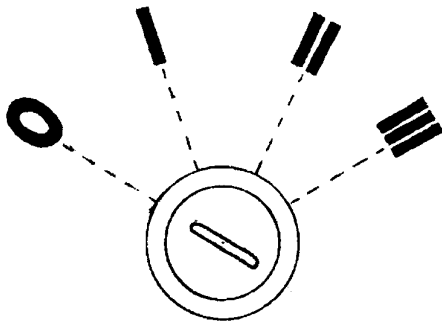

Turn the key to position I.

When the engine is cold : turn the key to position II and hold for five seconds. The orange light on the control console will indicate that the glow plug engine pre-heater is warming the engine.

When the engine is warm you can omit this step.

Now turn the key to position III and the engine will start.

After the engine starts, immediately let go of the key and it will return to position I.

- ⚡ Should either of the red warning lamps on the operator console for OIL or CHARGING remain illuminated when the engine is running, then the engine must be shut down and the fault reported to maintenance.

Stopping the engine.

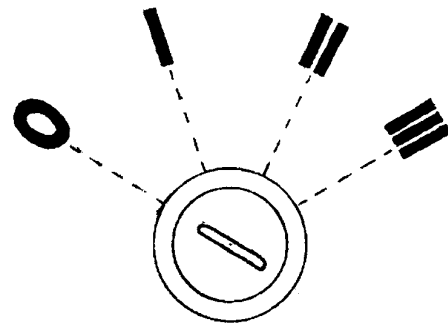

Turn the Key to position 0 and the engine will stop.

The emergency engine shut-off button.

If the engine fails to stop when the key is turned to position 0, then it is likely that there has been an electrical problem that is preventing the engine from shutting down correctly.

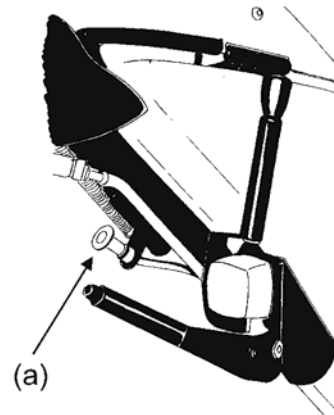



To stop the engine in this case, pull the red button (a) located under the handlebars on the right side of the machine.

Report the fault to your maintenance staff.

Setting the brush speed.

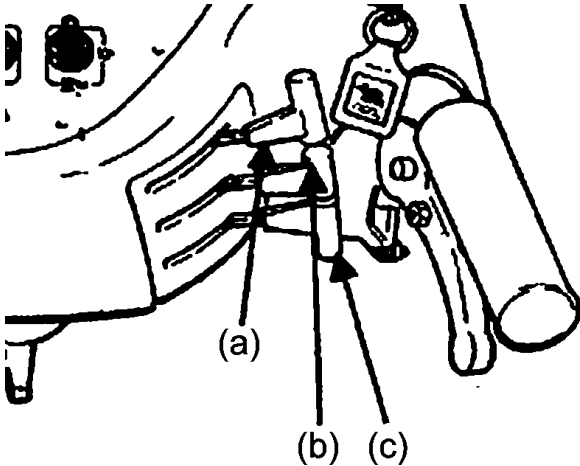

The brush speed lever is the bottom lever (c) on the right hand side of the operator console and has a black handle.

For normal sweeping set the lever at mid position.

The brush speed can be changed for different conditions.

For example, when sweeping a high volume of leaves or when scrubbing you can set the brush speed higher.

When sweeping glass, dog fouling, vomit, spilled food etc., then slow the brushes down.

If the brush speed is set too high, trash will be thrown too far across the path of the machine and the brushes will also wear faster.

If the brush speed is set too low, then trash will not be thrown far enough to allow pick-up, and also the brushes will tend to bounce up and down as you drive forward.

Setting the engine speed.

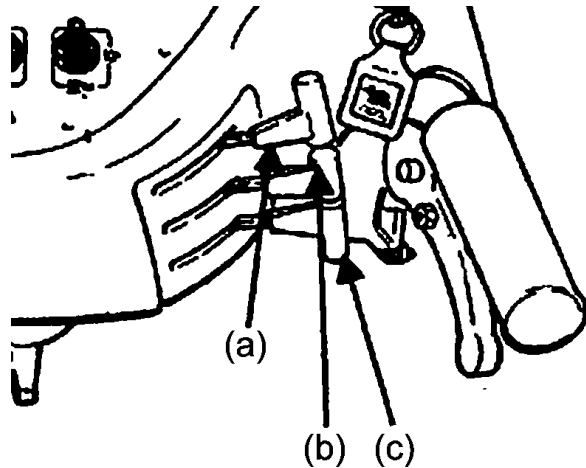

The throttle lever (b) is also on the right hand side of the operator console and has a red handle.

When running your machine, always use the minimum engine revs that you need to pick up the material being swept.

Start off with just under half power.

For machines equipped with a tachometer (rev counter) this would be 2200 r.p.m.

The throttle speeds will need to be set according to the nature of the debris you are sweeping.

Use a mid position for general sweeping such as dry litter and leaves.

You may need a three-quarter position for large volumes of litter.

You may have to use almost full throttle when sweeping heavy material such as thick deposits of grit and dirt.

Wet conditions will also need a higher throttle setting.

Try not to use too much throttle, particularly when your filter bag is clean at the start of your shift.

Too much throttle means too much airflow. The dust and debris that you pick up will blow into the plastic trash sack and will blow straight back out again. The dust will then be blown hard against the surfaces of the filter bag, which results in a loss of suction performance.

So although it seems strange at first, the lower



the throttle setting that you use, the longer your machine will sweep efficiently.

The Front Flap

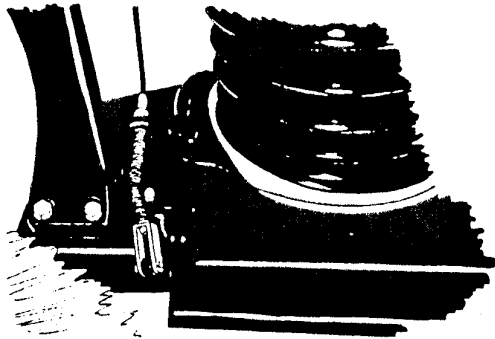

There is a flap opening at the front of the machine.

Opening the flap allows the pick-up of bulkier debris such as plastic bottles, paper cups, leaves etc.

When sweeping heavier debris such as sand or dust, the machine works best with the flap closed.

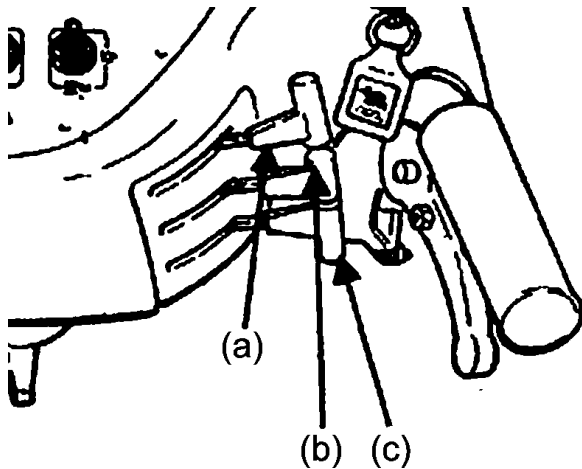

The topmost lever (a) on the control console operates the flap.

Driving forwards.

Always have both hands holding the handles. Check that it is all clear around you before moving off.

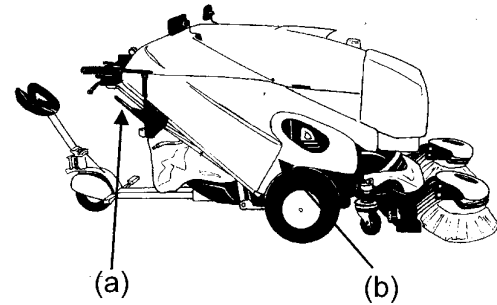

Check that the parking brake (a) is released.

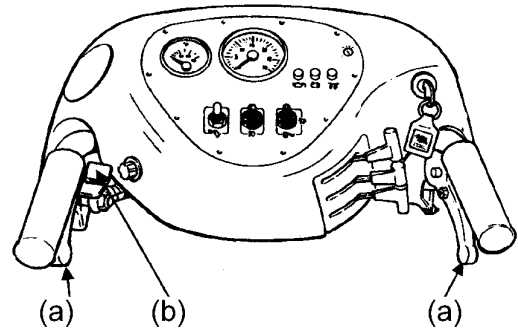

Using the right or left hand drive lever (a), slowly squeeze the lever until the machine moves forwards.

The more you squeeze, the faster the machine will drive.

Stopping.

To stop the machine in forward or reverse just let go of the drive levers.

The machine has what is called "hydrostatic braking" or a "dead man's handle" so that it will come to a controlled stop as soon as you let go of the drive levers.

Driving in reverse.

Always ensure that there is sufficient room behind you before reversing.

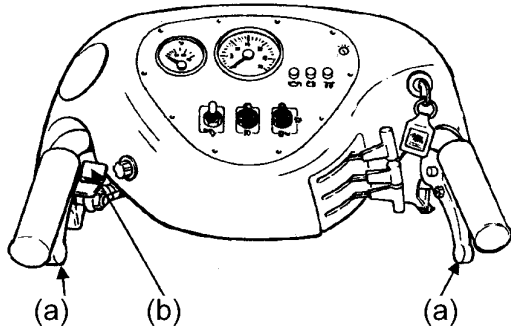

Pull back on the reverse drive lever (b) using your left thumb until the machine starts to reverse.

⚡ **To stop the machine in forward or reverse just let go of the drive lever.**

The parking brake.

The machine is driven by hydraulics. When the drive lever is operated the machine moves in the direction chosen. On releasing the drive lever the hydraulic system applies a braking force to bring the machine to a controlled stop. (This is called "Hydrostatic Braking").

However hydrostatic braking systems are not sufficient to stop the machine gently creeping down hills or inclines when the machine is left on unlevelled ground.

Therefore there is also a parking brake fitted to the machine that should be used when the machine is to be parked unattended.

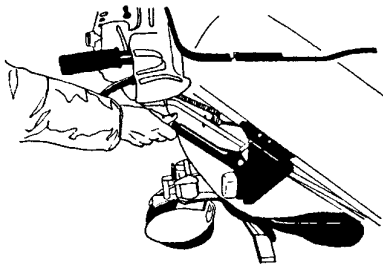

To engage the parking brake (a), push the brake lever downwards until it locks.

To release the parking brake, press the button on the end of the parking brake lever and then move the lever to the fully up position.

⚡ **Parking brakes are not fitted as standard on model 414S2D walk-behind models. Therefore do not leave this model parked on any hill or incline.**

The emergency brake release.

Because the hydrostatic braking system is engaged automatically when the machine is not being driven in forward or reverse, then the machine will be unable to be moved when the engine is not running.

If a situation occurs where the engine cannot be started and the machine needs to be moved, the emergency brake release can be opened. This is located on the right side of the machine as shown.

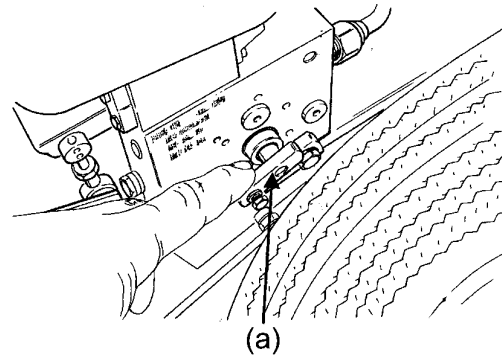

Open the emergency brake release (a) by turning it anti-clockwise just like a faucet. When done, close the brake release valve hand-tight only.

Do not use wrenches etc. since over-tightening can damage the valve.

⚡ **Do not open the emergency brake release if the machine is on a gradient unless the road wheels are chocked or the parking brake is applied.**

Chapter 6

The water system.

The water system is provided to control dust in dry conditions. When used correctly it will maintain the filter bag condition for longer periods and will avoid dust escaping from around the brushes or from the filter bag.

The system controls.

There are two versions of water control depending on your model:

Variable speed water pump version (424 Series).

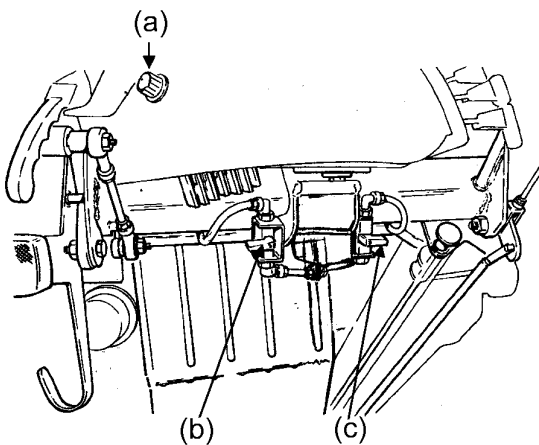

The water pump speed control knob (a) is used to vary the amount of water that is sprayed. The two valves below the console are used to turn the brush sprays (b) or the inside filter bag spray (c) on or off as required.

Fixed speed water pump version (414 Series).

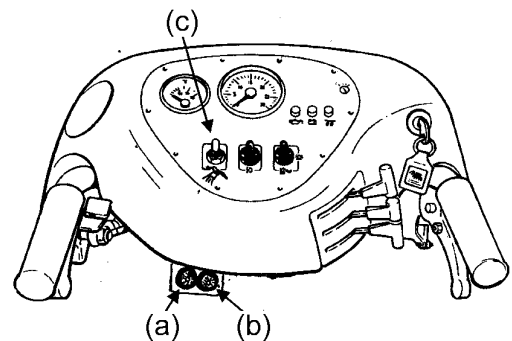

There is no separate water pump speed control. The water pump is turned on using a switch (c) on the console.

The amount of water to be used is adjusted by opening the control valves under the console.

You can vary the amount of water to the brush jets (a) or inner bag jet (b) by opening or closing the valves.



The Bag Spray Jet

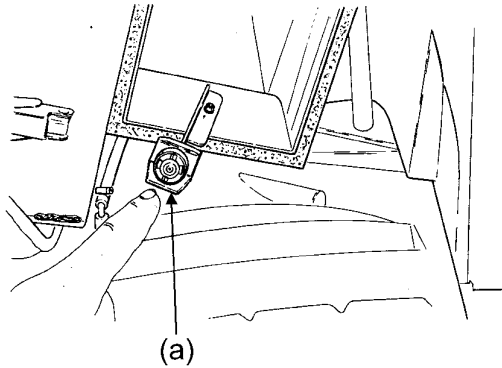

The bag spray jet (a) is designed to damp down any dust just before the air and debris reach the plastic trash sack.

The jet has a very effective fine misting action and should be left on at a low setting during sweeping where dust is present.

Before you start sweeping you should check that it is spraying correctly.

⚡ **Do not open the back trunking without switching the engine off and removing the starter keys.**

The filter behind each jet must be cleaned periodically and replaced if damaged.

The jets can be removed easily. Please see the Chapter 15 - Faultfinding at the end of this manual for more details.

The brush spray jets.

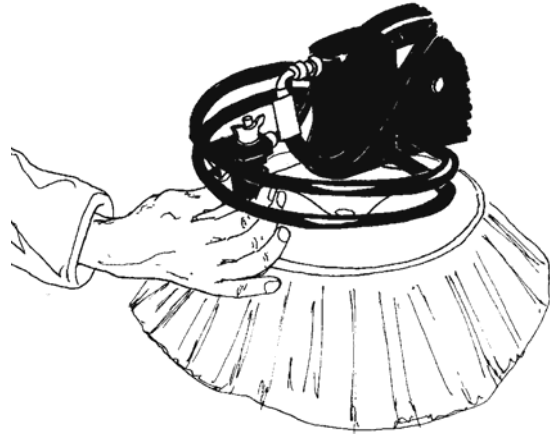

These are used to suppress dust that may be kicked up by the brushes.

The brush sprays should normally only be used when sweeping in very dusty conditions, or when spot scrubbing.

⚡ **Do not use the front spray jets when sweeping on light-colored or very porous surfaces. The wet brushes may leave dirty swirl marks on the surface.**

The water tank and filler gauge.



The water tank holds 55 liters (13.5 U.S. Gallons) of water and is filled via the red



filler cap (a) shown above.
Under normal sweeping conditions, a full water tank should last approximately 2 to 4 hours.

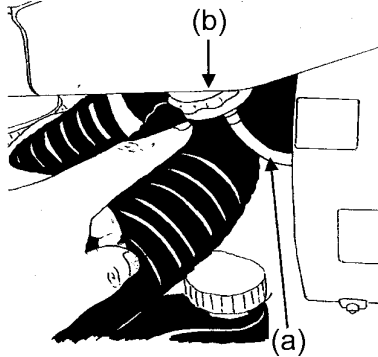

There is a drain cap on the bottom of the tank to allow water to be drained from the tank. Disconnect the water tube by pushing on the metal tab on the quick release coupling. Then unscrew the drain cap.

- ⚡ **During very cold weather you should drain the tank when the machine is not in use so as to prevent freezing and possible damage.**

Drain the tank and then let the water pump run for a few seconds to empty out all the water. The water tank drain cap also has a filter screen inside which should be cleaned periodically.

Use of disinfectants or chemicals.

You may wish to add a disinfectant and/or mild degreaser to your water system to improve hygiene and performance.

If so, then add a small amount of the product to the water tank before filling with water.

Make sure that you follow the correct dilution instructions marked on the product.

Take care as to which products are used. We recommend "Simple Green" or any similar quaternary-ammonium halide based products.

- ⚡ **Do not use products that contain methanol, which can damage the water pump seals.**
- ⚡ **Do not use products that turn a milky color when mixed with water. These contain colloidal deposits that can gum up the water pump seals.**
- ⚡ **Never add herbicides or any other products containing poisonous or harmful chemicals to the water system. There is a strong risk of inhalation of the product as it is vacuumed up by the machine.**

Chapter 7

The wander hose.

The wander hose allows you to clean in areas not normally accessible to the machine such as between parked cars, behind street furniture, tree gratings, flower beds, etc.

Using the wander hose.

For most applications, the hose can be used when machine is in sweeping mode.

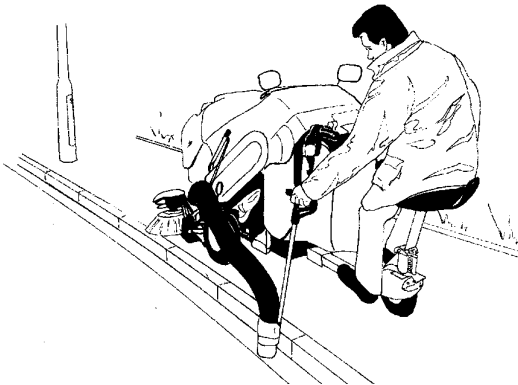

Just remove the hose from its holster. The hose will start to suck automatically.

This way about 30% of the suction comes through the wander hose, and about 70% of the suction continues through the front suction nozzle.

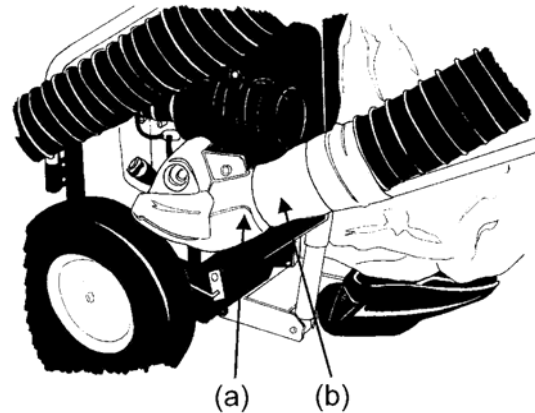

When you replace the wander hose (b) in its holster, the hose sucks on to the plastic "bullet" (a) and stops the suction airflow automatically.

The blanking plate.

If you wish 100% of the suction to go through the wander hose, then you can use the blanking plate supplied with the machine to block off suction to the front suction nozzle. This is useful when cleaning out tree pits or other heavily soiled areas.

⚡ **First ensure engine is switched off and keys are removed from ignition switch.**

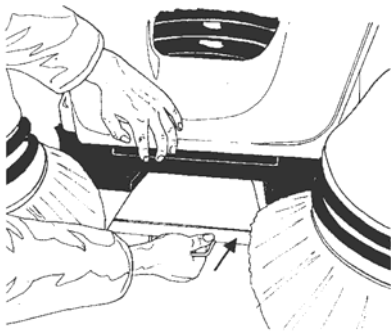

Then lift up the flap and insert the plate into the groove in the suction nozzle.

Lower the flap.

The blanking plate is also useful if you want to transit from one place to another without sucking anything up. (For example if you need to pass through an area of construction debris.)

Unblocking the wander hose.

If the wander hose should become blocked:



Place the blanking plate into the suction nozzle.

Lay the Wander hose out in a straight line.

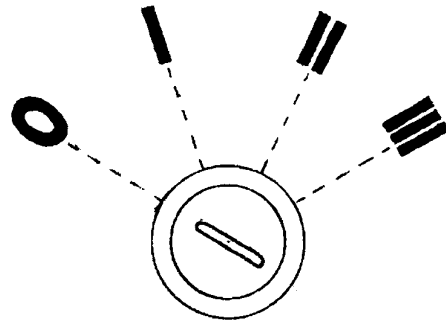

Start the engine and set the throttle to about 1/3rd power.

Grasp the wander hose handle and pull sharply on it so as to straighten the hose out.

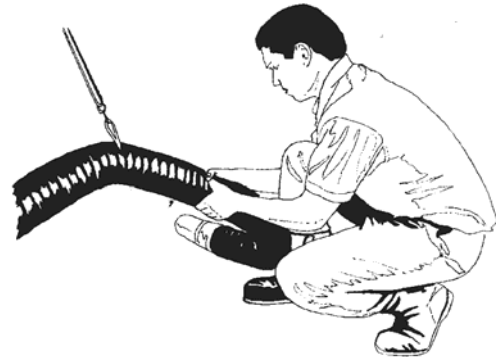

If the blockage is still there, gently squeeze along the length of the wander hose until the blockage is found.

Then squeeze the blockage area until it clears.

Chapter 8

Sweeping with your Green Machine.

Sweeping in wet weather.

When sweeping in wet conditions:

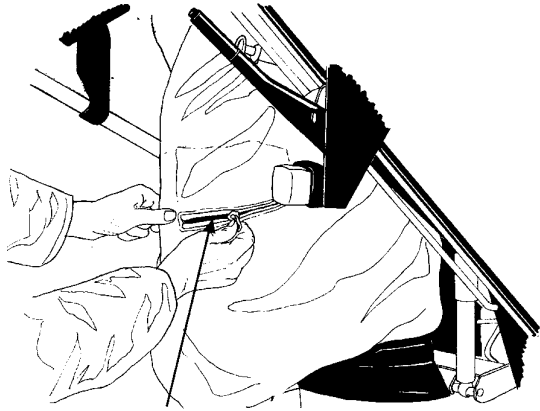

A wet filter bag will not allow air to pass through it very well, so to overcome this problem open the side zip which allows the bag to vent.

⚡ **Switch off the engine and remove the key before opening the fan casing sludge door.**

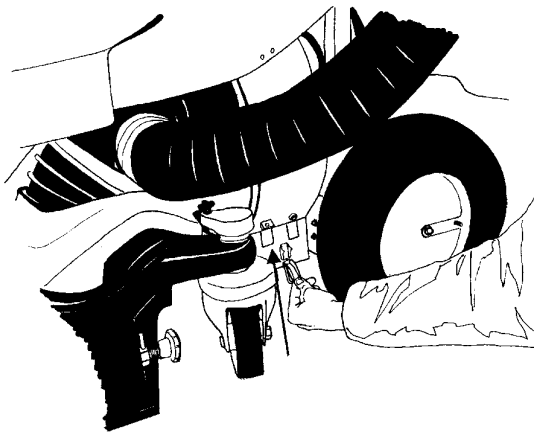

The sludge door allows excess water to be

drained back onto the sidewalk. Always remember to close the sludge door when sweeping in dry conditions to prevent dust and debris from blowing out. It is also advisable to pierce one or two holes in the plastic collector sack to allow any further water to drain.

Sweeping along curbs and buildings.

When you first start to use the Green Machine in a new area, there is a surprisingly large amount of dirt and dust to be picked up. Once you have swept the area regularly, then the amount of dusty debris will reduce substantially.

The problem is that when you are new to your machine and the machine is new to an area, you have the hardest job to do when you have the least experience with your machine.

Most of the heavy dirt collects along edges, either between the sidewalk and buildings (the "building line") or between the street and the curb (the "curb line").

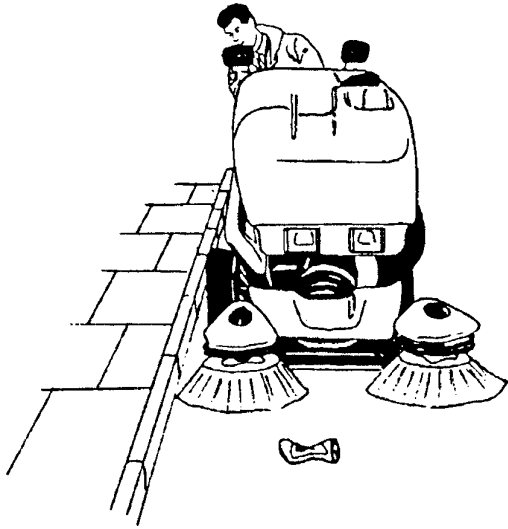

The Green Machine is not designed as a full-sized street sweeper. However it is capable of maintaining curb lines if they are moderately dirty.

Because around 90% of dirt generally sits within the nearest 18 inches of the building line or curb line, then the best way to tackle your area is to start by spacing your machine away from the curb-line or building line by about 12 inches.

The next time you sweep the area, sweep slightly closer to the edge, until finally on your third or fourth pass you can sweep with the brushes right up against the line.

Taking "cuts" at the edges like this will help you a lot.

Remember to use the water spray in the filter bag to keep the bag from getting dusty and losing performance.

Also remember to use the minimum engine speed you can to avoid blowing dust out of the plastic collection bag and onto the surfaces of the filter bag.

Drive forward slowly to allow time for the heavier debris to be picked up.

When sweeping curb-lines always remember to sweep in the general direction of traffic flow.

Use lights, beacon and warning beeper and wear reflective safety clothing.

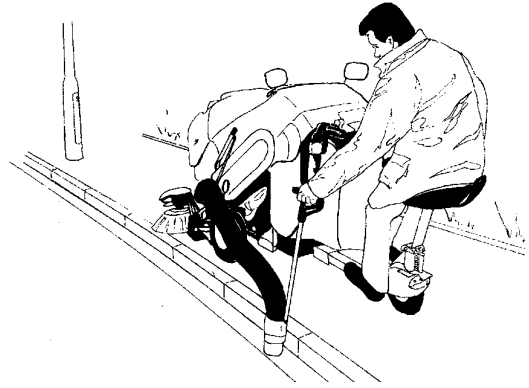

Alternatively, use the wand hose to clean the curb.

Sweeping corners.

To clean out corners, drive the machine into the corner about 18 " away from the adjacent wall.

Stop when the brushes touch the opposing wall. Swing the handlebars to the left and right to move the machine left and right. This gathers up the debris into the suction nozzle.

Reverse the machine by about two feet. Now turn the machine and drive past the opposing wall, ensuring that neither the handles nor brush arms hit the walls.

Climbing and descending curbs.

Always try and climb or leave the pavement/sidewalk by using handicap access ramps.

Where this is not possible, never try and climb or leave the curb whilst sitting on the seat.

With care and practice, the machine can be maneuvered up or down curbs of a 4" maximum height.

However, there is a high risk of machine accident damage when mounting or descending curbs.

Avoid them if you can.

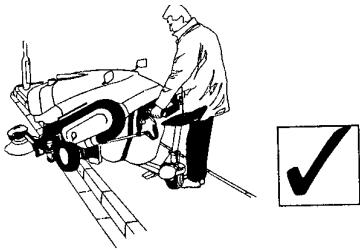

When descending the curb, move slowly forward at a 45-degree angle, until one wheel drops down.

The handlebars will move up towards your chest as the front of the machine descends, but hold the handles firmly so that the machine stays on course and doesn't swing to the side.

Climbing a curb is similar, except you must push down firmly on the handles before mounting the curb, and then keep them down so that the front brushes and castor wheels clear the curb as you drive forwards.

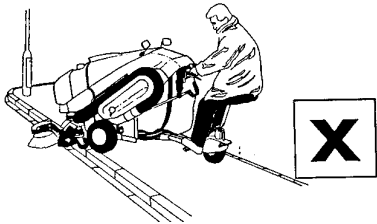

⚡ **Never climb or descend a curb when riding the machine. Always get off the seat.**

Transporting the machine.

When moving the machine from one area to another:

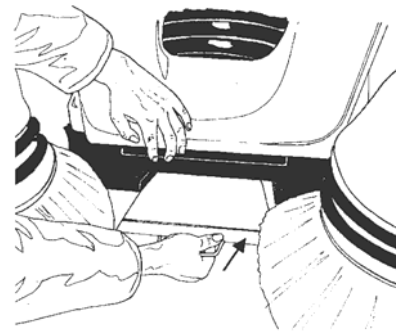

Place the blanking plate into the suction nozzle grooves to prevent suction pick-up.



Latch the brushes up when traveling to your sweeping location.

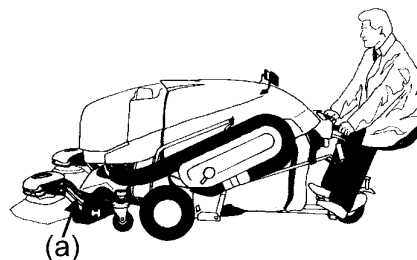

To travel longer distances the machine should be transported safely by using a correctly-fitted trailer.



Objects to avoid when sweeping.

Most items encountered under normal conditions (such as paper, litter, leaves, cans, bottles and glass) can be swept up without a problem. However there are a few items you should try to avoid sweeping.

Rope, string, nylon or metal banding.

These may wrap around the brush motors or suction fan.

Large plastic bags or items of clothing.

These may block the suction hose or wrap around the suction fan.

Bricks and large stones.

These won't get picked up and will just be dragged along under the suction nozzle.

Pieces of wood.

These can be sucked up and can jam or damage the impeller fan.

Aerosol cans.

It is advisable to retrieve these by hand as they could contain inflammable gas or liquids.

Oil-Sorb granules or other oil-laden debris.

Oil-impregnated debris such as absorbent

granules should not be swept. This is because the impeller fan pulverizes the granules into a powder that sticks to the filter bag. You will lose suction performance and will have to wash the filter bag in a washing machine. (see Chapter 14 for instructions on filter bag care).

Unblocking the suction nozzle.

Should the front suction nozzle become blocked:

⚡ **Switch off the engine and remove the key.**

Tilt the machine backwards.

Remove the blockage by reaching in under the suction nozzle and pulling the debris clear.

⚡ **Always wear safety gloves when removing debris in this way.**

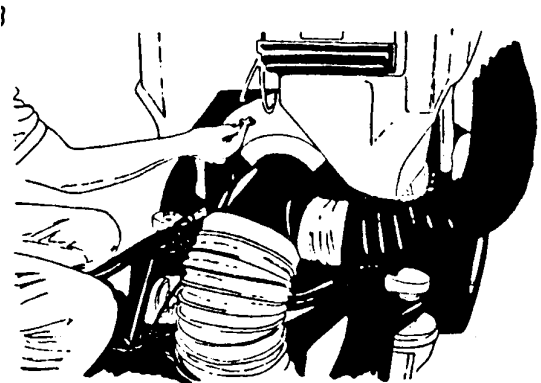

If this is not possible to reach the blockage, then remove the front suction hose by unscrewing the six black knobs that hold the suction hose to the impeller fan housing. There is also one black knob to remove at the bottom end of the suction hose.

⚡ **Remember to first switch off the engine and remove the key.**

Chapter 9

Model 414RS.

The Ride on Seat offers the operator greater comfort and the ability to sweep larger areas with little or no additional effort.

Extending the seat.

When using the machine in the walk behind mode and you want to extend the seat. Bring the machine to a stop in a clear and safe area.

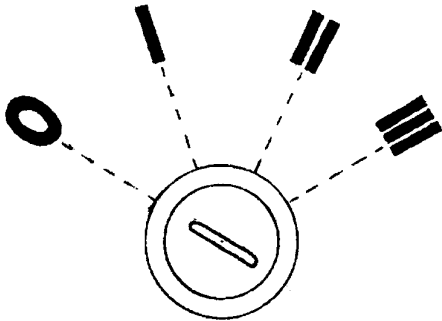

Turn the machine off.

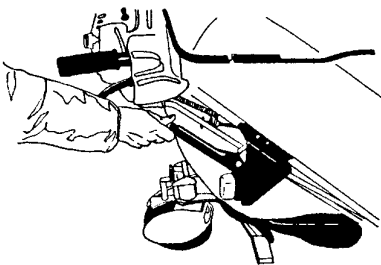

Apply the parking brake.



Push the locking lever inwards to release the seat.

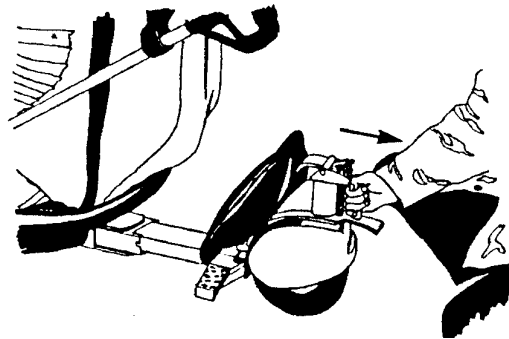

Pull the seat slider unit out fully until it locks.

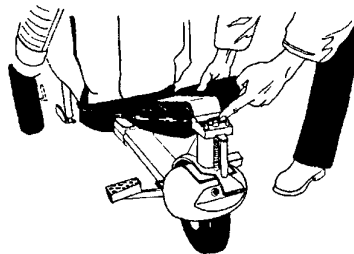

Make sure the rear wheel is aligned with the locking plunger.

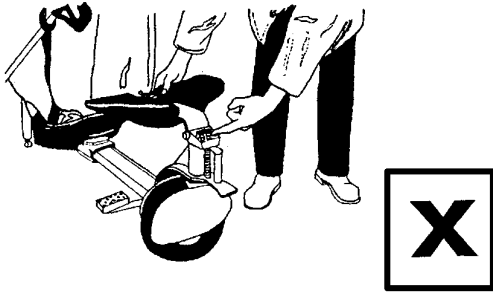

If the rear wheel is not straight the seat cannot be raised.

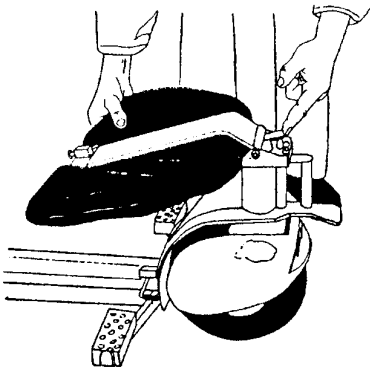

When the wheel is straight the lug shown above will push a locking plunger down and lock the castor wheel into position.

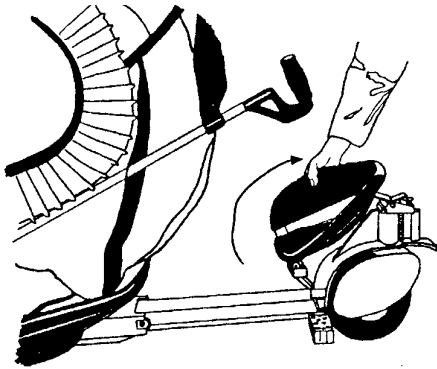

Now raise the seat stem.

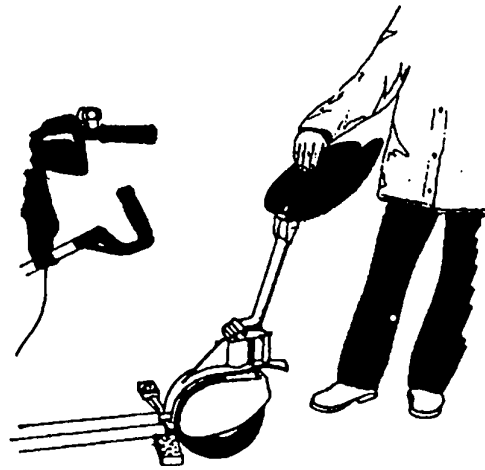

Finally extend the seat pan.

Stowing the seat.

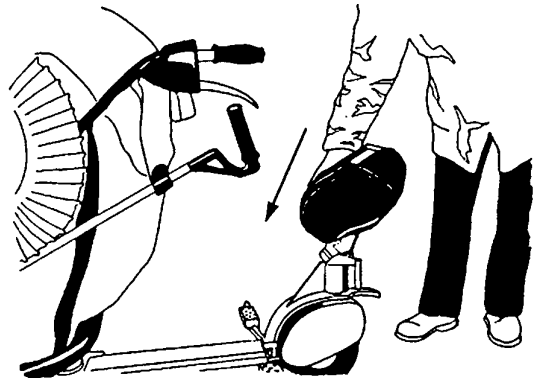

Fold the seat pan forward.

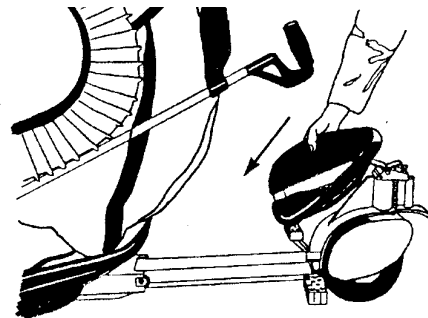

Fold down the seat stem.

Pull out the locking lever towards you. Ensure that the slider unit is exactly in line with the machine.

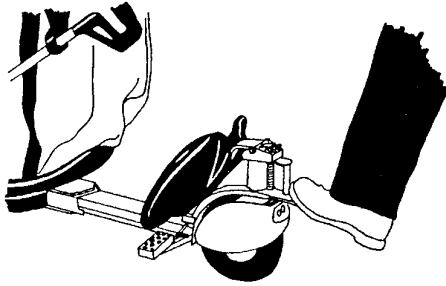

Put your foot on the pedal and push forward until the slider locks fully closed.

Using the seat safely.

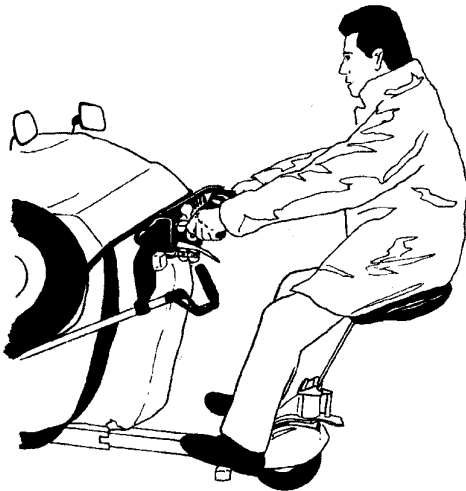

Always have both feet on the footplate.
Always have the seat correctly adjusted.
Always have the wing mirrors set for good rearward vision.
Always ensure you release the parking brake.

When to use the seat:

In areas of low pedestrian flow.
Where it is safe to do so.
When transiting from one place to another.

When not to use the seat:

When the pavement / sidewalk is crowded with pedestrians.
On the street in heavy traffic conditions.

In confined areas.

Turning.

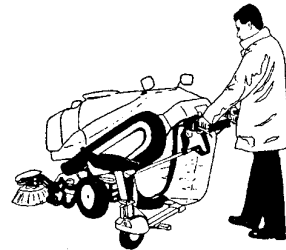

The machine can turn in its own length. To do this, get off the seat. You should bring the machine to a complete stop, and then get off on the opposite side to the way you are turning.

For example, if you want to make a left turn, then step off the seat on the right side. Once you have completed the turn get on the seat again.

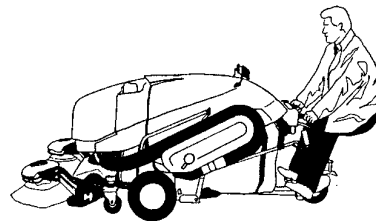

Always remain seated unless mounting or dismounting the machine.

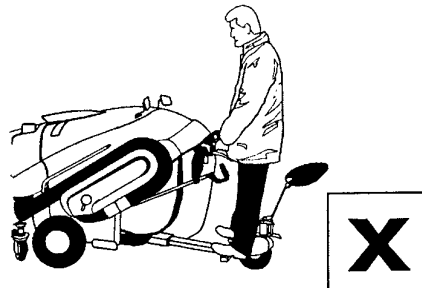

Never stand using the seat.

Seat adjustments.

Having extended the seat it is important to



ensure that the seat is correctly adjusted for the individual operator.
There are two points for adjustment of the seat.

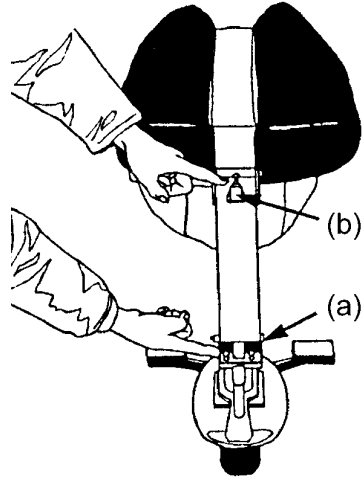

The lower button screw (a) moves the seat stem forward and rearward.
The upper button screw (b) controls the angle of the seat pan.
The seat should be adjusted so that when seated, most of your body weight is

supported by the legs and not via the seat.

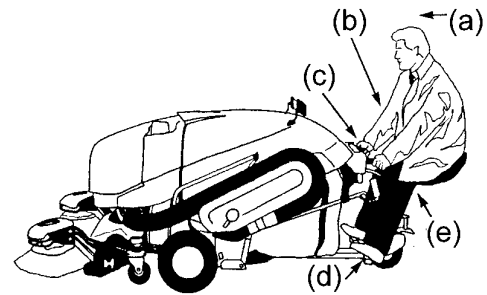

You should ensure that:

- You have adequate forward vision (a)
- Your elbows are slightly bent..... (b)
- Both hands hold the handles (c)
- Your feet are comfortable on the footrests (d)
- Your legs are bent and supporting most of your weight (e)

This will provide more comfort during machine operation.

Chapter 10

Models 424TR and 424HS.

Both these models feature a comfortable two-wheeled suspension seat.

The model 424HS also offers two speed ranges: 0-5mph(8km/h) and 0-10 mph(16km/h).

The model 424HS also has a front suction nozzle that can be raised or lowered from a switch on the operator console.

To fit the seat unit.

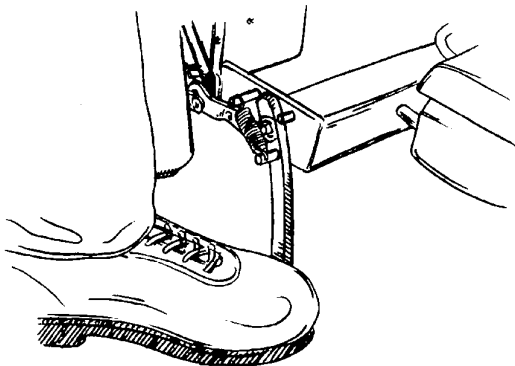

First set the kickstand on the ground using your foot. This will support the rear of the machine in the correct position for attaching the seat.

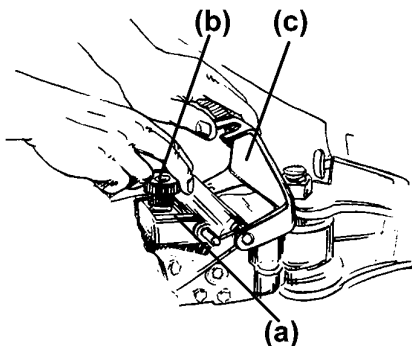

Remove the dolly wheel assembly from the rear

of the machine by first lifting up the yellow cover (c).

Turn the lock screw (b) anticlockwise to loosen. When loosened sufficiently, swing the lock screw rearwards to clear the locking plate (a).

Lift up the locking plate and remove the dolly wheel.

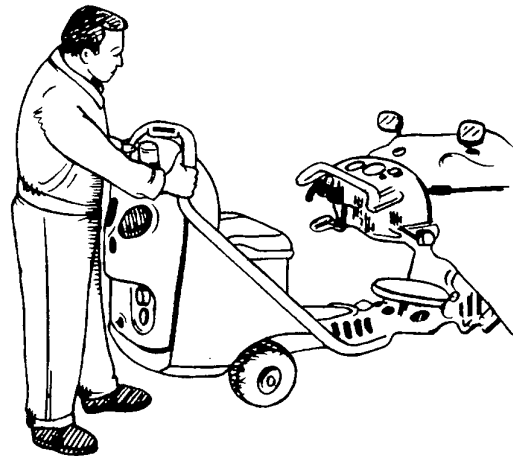

With the dolly wheel removed, hold on to the seat unit and guide the seat forwards onto the guides on your machine.

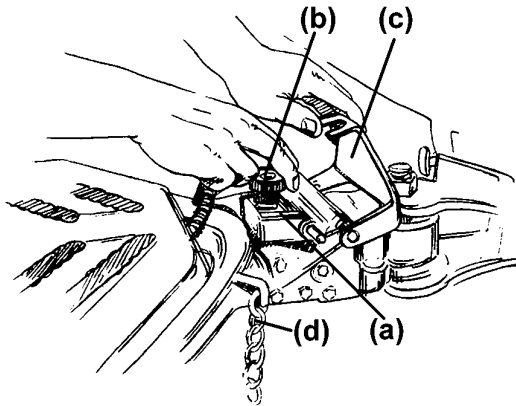

Push down on the locking plate (a), slide the lock screw (b) into position and screw it clockwise until hand tight. Align the locking screw with the yellow cover (c) and close the cover. Reattach the safety chain (d). Finally, insert the electric plug for the rear lighting into the socket. The kickstand should spring-back to the closed position when you drive forwards with your machine. To remove the seat, follow the same procedure in reverse.

Adjusting the seat unit.

The seating arrangement on the 424 series of Green Machines has been designed for maximum comfort. The seat rake can be moved back or forwards by sliding the lever at the front of the seat. The amount of recline is also adjustable using the hand-wheel on the right side. There are three weight settings on the spring suspension unit under the seat. Push on the segment button at the top right side of the seat unit to adjust the spring rate.

Adjusting the footplate and handle height.

The footplate height can be adjusted to fit you in

comfort.

To raise the footplate, first unclamp the two toggle clamps. Lift the footplate up into a new position, and re-clamp the toggles. To adjust the handle height, turn the large adjuster screw that is located under the control console.

Selecting high-speed mode (424HS only).

To select the high speed range on the model 424HS:

⚡ **First ensure the machine has come to a complete stop.**

Next reduce the engine throttle to idle. Pull-up and move the switch on the control panel from the tortoise position (slow speed) to the hare position (high speed).

The machine will now travel in high-speed mode. Please note that the acceleration in high-speed mode is less than in low speed. High-speed mode should be used when transiting from one place to another with the front suction nozzle in the raised position.

High-speed mode is not recommended for normal sweeping.

This is because you may cause damage to the suction nozzle or sweeping gear if you collide with objects such as raised drain covers when you are traveling at faster speeds.

Raising and lowering the suction nozzle (424HS only).

⚡ **First ensure that the machine has come to a complete stop.**

Bring the engine throttle to the idle position.



Then select the nozzle up position using the switch on the operator console.

The front suction nozzle assembly, brushes and castor wheels will be raised clear off the ground to allow easy transiting in high-speed mode.

As well as raising the front nozzle, the switch controls the pitch-lock mechanism, which is shown below.

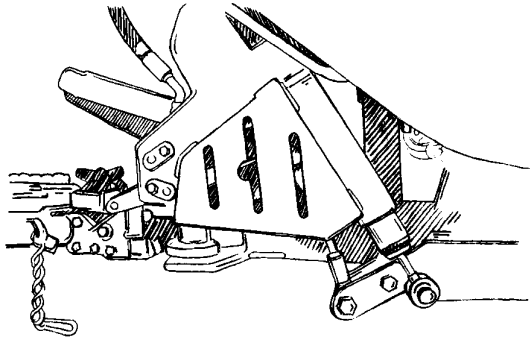

The pitch-lock engages automatically when the front suction nozzle is raised.

The pitch-lock is designed to limit the range of movement of the handlebars when the front suction nozzle is up.

This prevents the handlebars from hitting the operator's knees when transiting over uneven surfaces and gives a more stable and secure ride at high speeds.

Chapter 11

The Clean and Safe Attachment.

This option is useful for the hygienic removal of anti-social deposits. It is often called the “CSA” or “DEA” for short.

The CSA/DEA suction hose.

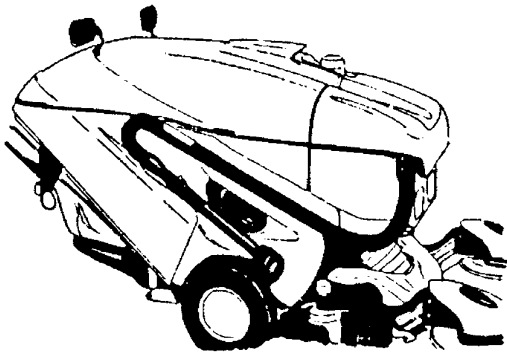

The hose is of a much smaller diameter than the wander hose and is situated on the right hand side of the machine. The hose has a flexible cuff to assist in sucking up animal fouling.

The CSA/DEA water system.

The hose has its own water supply, which is designed to assist the operation of the CSA and help clean up the area where the animal fouling lays.

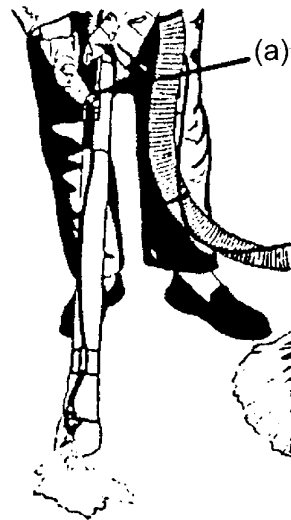

A shut off valve (a) is located on the suction hose.

The CSA/DEA container.

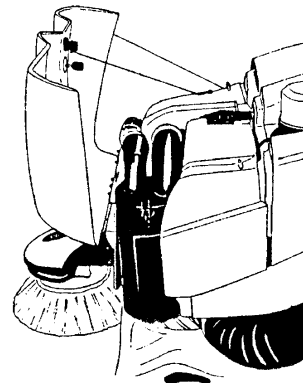



The container is located under the front cover of the machine and can be used with our without plastic sack liners.



A single peg on the rear locates the container.

CSA/DEA preparations.

Insert the special CSA/DEA plastic sack and cardboard tube into container.

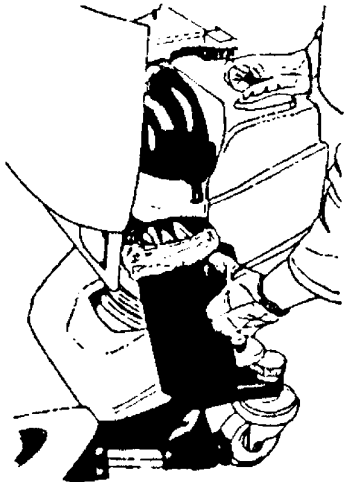

Replace the container on the machine.
Ensure that the water tank is full.
Add 1 litre (2 pints) of neat disinfectant to the machine water tank.

Using the CSA/DEA.

Ensure that the engine is set to idle (throttle

closed).

 **Starting up the CSA/DEA with too high an engine speed can damage the machine.**

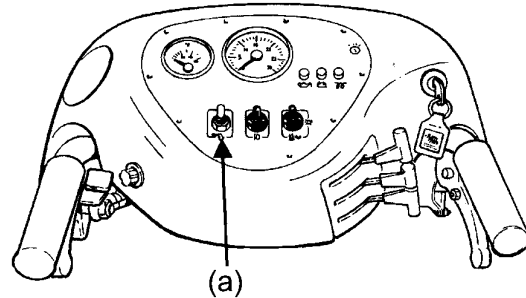

Switch on the CSA/DEA unit by lifting up the switch on the control console and pulling it rearwards.

Increase the engine power to approximately 2/3rd power.

Remove the lance and hose from the holster on the right hand side of the machine.

Open the water valve on the lance.



Lightly spray the fouling with water /disinfectant mixture and then shut off water valve.

Place the hose end over the soiled area and then draw the hose toward you.

Continue until all of the soiling is removed.

Open the water valve on the lance once more and spray the area with water/disinfectant solution.

Finally suck up any remaining residue.

Stow the suction hose back in its holster.

Switch off the CSA/DEA by first closing the engine throttle.

Then lift the switch on the control console up



and forwards.

Now you can continue normal sweeping.

When the CSA/DEA system is active then the machine will not drive.

The same procedures apply for de-fouling grassed areas.



Always wear hand protection when using the CSA/DEA unit.



Always make sure that you use disinfectant in the water system.

Chapter 12

Leaf Sweeping.

In the Autumn / Fall, the machine can be fitted with a high volume leaf bag.

Using leafing bags.

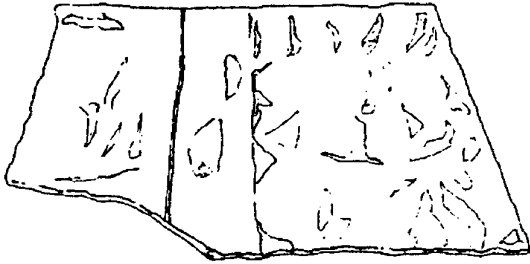

Leafing bags have several advantages over the plastic trash sack system:

They have a much larger capacity than the plastic trash system - they will collect around ten times the volume of leaves.

They are fast to change out.

They are inexpensive so that you can use several during a shift - when a bag gets full, you can leave it on the street and fit a new one. The dropped-off bags can then be picked up at the end of the day, emptied and reused.

The open "burlap" weave allows much greater airflow and therefore improved suction performance, allowing the machine to work faster when picking up large quantities of leaves.

The improved airflow also reduces the number of blockages.

Leafing bags are not recommended for every day sweeping as they have one major drawback:

The open weave means that there is no final filter stage and so dust output is much higher.

When sweeping on grassed areas make sure that the brushes are adjusted so that they

just touch the grass. Too much brush pressure can leave deep swirl marks.

Also when picking up leaves it is best to raise the height of the front nozzle, and to open the front flap.

These together increase the clearances at the bottom of the suction hose and reduce the tendency for twigs and small branches to create "bird nests".

You will encounter blockages when sweeping piles of leaves which contain many twigs and small branches above 8" (200 mm) in length.

Just follow the procedure in Chapter 8 for unblocking the suction nozzle.

Use the water sprays to damp down any leaf mold that may pass through the coarse weave of the leafing bag.

Fitting the leafing bag.

⚡ Remove the Starter Keys first!

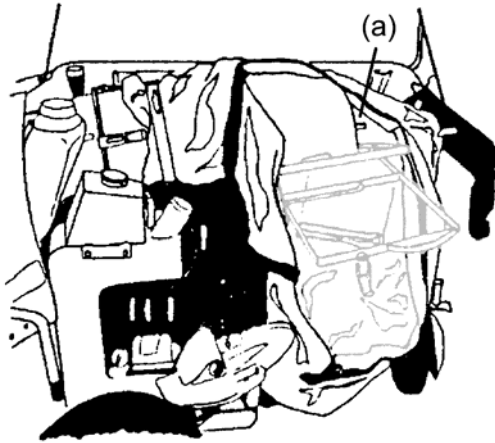

Remove the sliding frame, filter screen and holder by opening the toggle clamp (a).

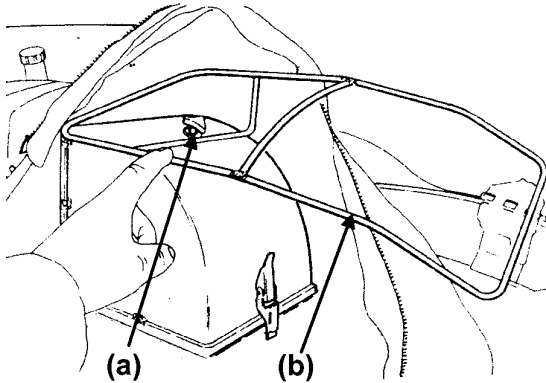

Loosen the panel knob (a) and remove the bag support frame (b).

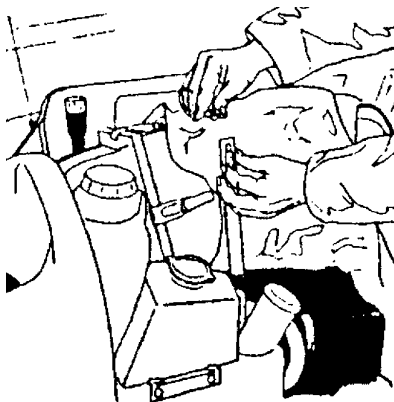

Remove the outer filter bag.
Refit the bag support frame.

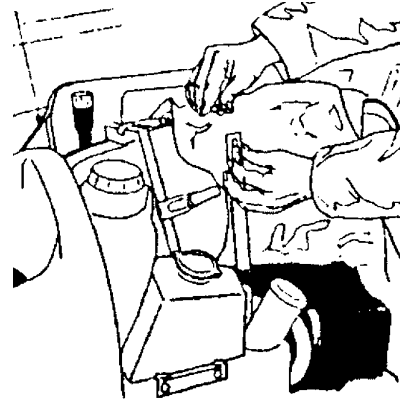

Fit the leaf bag in the same way as the outer filter bag in the same way as the outer filter bag is fitted using the bag strap.

Fit the protective apron by hooking the right side hole in the apron over the hydraulic tank filler.

Then unscrew the water filler cap and hook the left side hole in the apron over the water tank filler. Retighten the water filler cap.

Close the machine top cover.

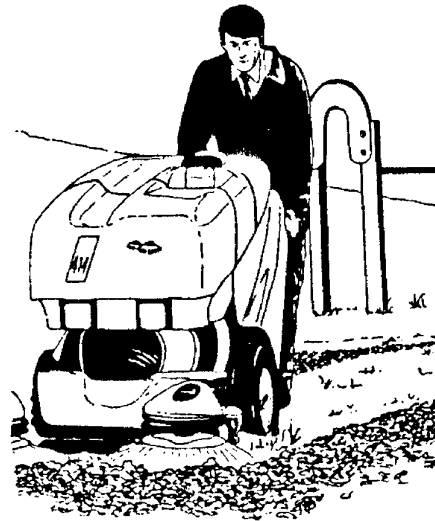

Once fitted, the machine can then effectively deal with leaves on hard surfaces or grassed areas.

Chapter 13

The snowplow option.

During winter, the machine can be fitted with the optional snowplow attachment.

Fitting the snowplow.

The Green Machine can be converted to a snowplow within a matter of 30 minutes.

↶ **First remove starter keys!**

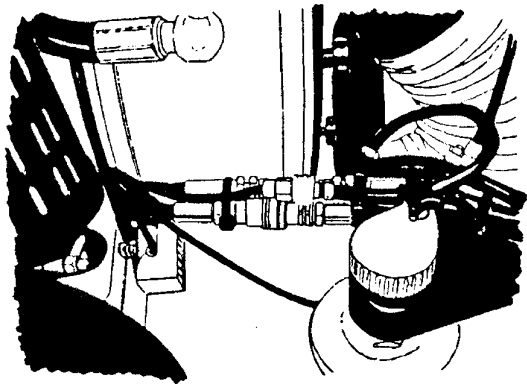

Disconnect the three hydraulic couplings on the right hand side of the machine.
Disconnect the water hose in the same location.

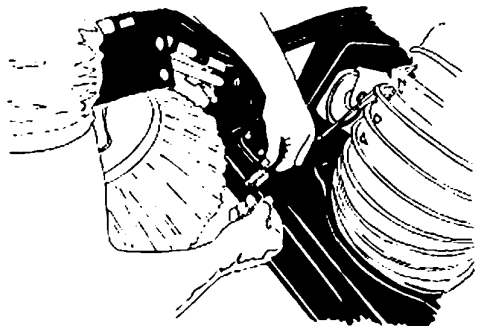

Remove the flap cable split pin and clevis.

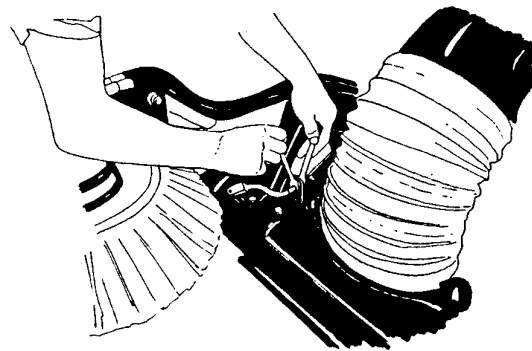

Release the threaded adjuster from its anchorage by loosening the nut with a wrench.

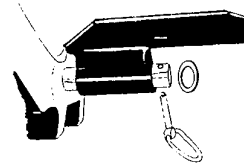

Remove the pin and washer from the suction spigot.



Remove the front box assembly.

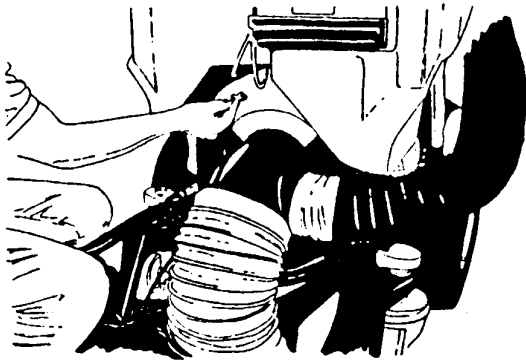

Remove the front suction hose assembly by unscrewing the six knobs on the fan casing access cover and unscrewing the single knob at the base of the suction hose.



With one person holding the machine handlebars, a second person should pull the suction nozzle assembly completely away from the machine.

Place the casing blanking plate that came with the snowplow over the fan casing and

secure it with six of the panel knobs that you removed earlier.

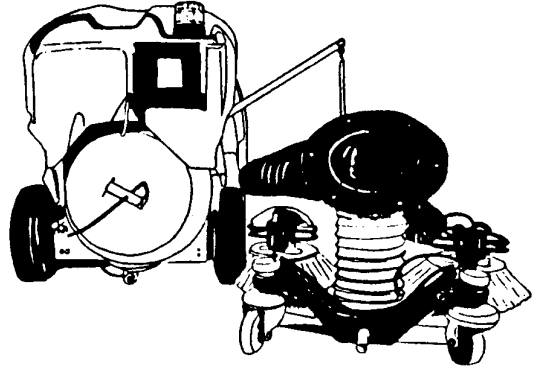

Secure the flap cable to the casing blanking plate handle so that it does not drag along the ground.

Next unclip the wander hose from the boom and remove the suction nozzle assembly.

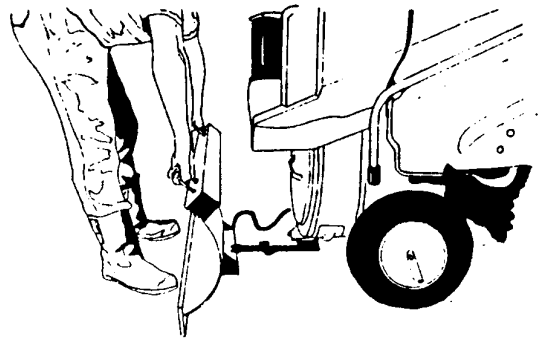

Slide the snowplow pivot pin into the fishplate tube on the machine.

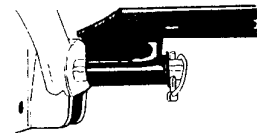

Then refit the lynch pin.

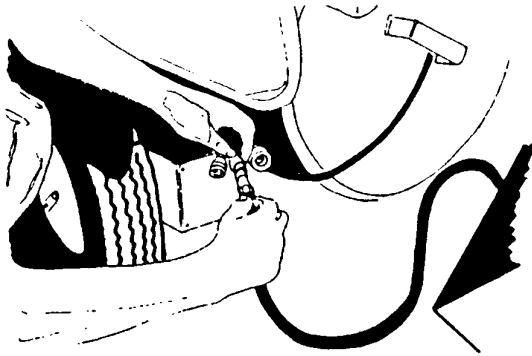

Connect the snowplow spray bar hose to the water system.

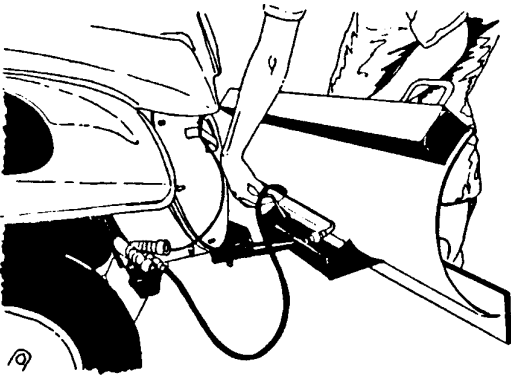

Position the snowplow to either left or right as required and install the locking pin.
Replace the front box assembly.
Fill the water tank with an approved deicer (please see the next section).
Check the sprays on the spray bar for correct operation.

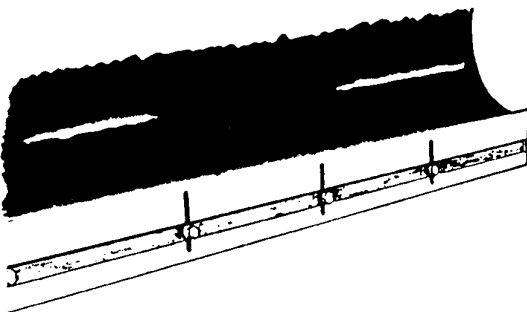

Finally make sure that the snowplow rubber is set correctly with no more than 18mm (0.75") protruding below the snowplow blade.



The machine is now ready as a footpath / sidewalk snowplow.

Maximum snow depth.

It is worth noting that due to the Green Machine having only 14 horsepower, the maximum depth of dry powder snow that the machine will handle is around 4" (100 mm). The plow will be ineffective in greater depths, or in wetter snow conditions.

Choice of deicer.

Fill the water tank with a liquid deicer such as liquid Magnesium Acetate, liquid Calcium Chloride, liquid Calcium Magnesium Acetate or approved equivalents. Do not use glycol-based or methanol-based antifreeze products so as to avoid damaging the water pump sprayer.

Care should be taken to wash the machine thoroughly after use since many deicing chemicals are corrosive.

Remember to keep the bag spray jet switched off when operating the deicer spray bar.



Chapter 14

Machine care and wash-down.

At the end of each use it is most important that the machine receives a thorough cleaning.

This is required for two main reasons:

Firstly the filter bag needs to be thoroughly cleaned to allow the machine to maintain suction performance.

Secondly, build-ups of dirt can shorten the life of your machine. The machine radiator needs to be clean to cool the engine and hydraulics, and other parts of your machine may suffer from the effects of dirt build up.

- ⚡ **Always remove the starter key before commencing the wash down.**
- ⚡ **Do not wash the machine while the engine is running**
- ⚡ **Avoid wetting the safety switches(wipe clean with a cloth)**
- ⚡ **This is because you might accidentally spray water near the engine air filter, and water may then be sucked up through the air filter intake screen. If this happens the water may enter the engine, which can be damaged beyond repair.**

End of use wash down.

Position the machine at the wash down area to allow free access around all points of the machine.

For the model 414RS, wash the machine with the seat unit fully extended.

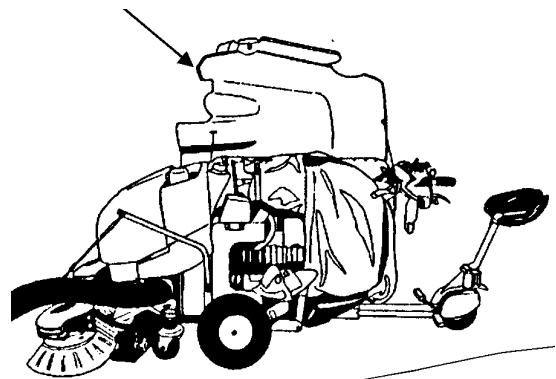

Open the machine top cover.

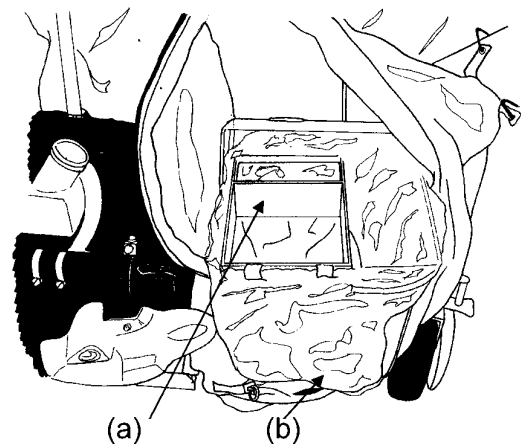

Unzip the outer filter bag and remove the inner plastic sack (b) and filter screen (a).

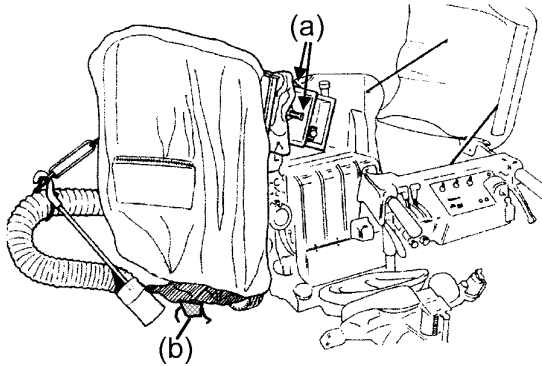

Unclip the two toggle clamps (a) to release the back trunking.
Swing out the back trunking until it locks in position.
Untie the drain tube (b) on the bottom of the filter bag, and gently shake the bag to let dust and sand escape out onto the ground.

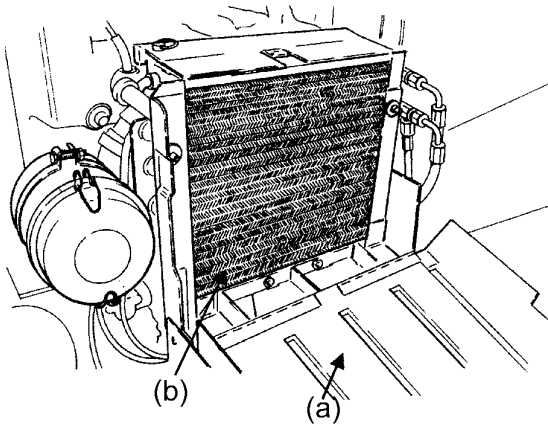

Open the radiator cover door (a).

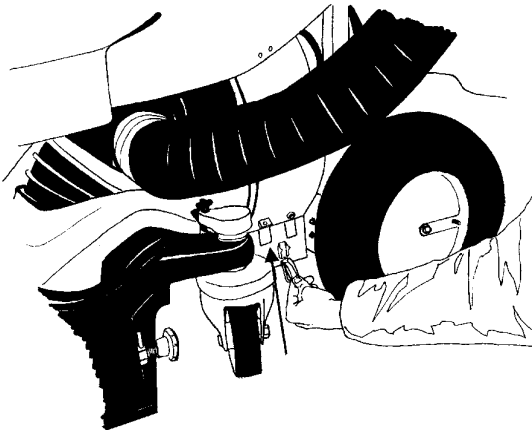

Open the sludge door at the bottom of the fan casing to let the water drain out.



First wash out the back trunking and down into the impeller housing area.
Then fill the wand hose with water by holding the suction end of the wand hose upright, and spraying your washing hose inside for twenty seconds.
Pull the hose straight and raise the handle up at the same time.
This will cause the water laying in the hose to run into the impeller fan housing, and will wash dirt out through the sludge door.
Repeat this process several times.

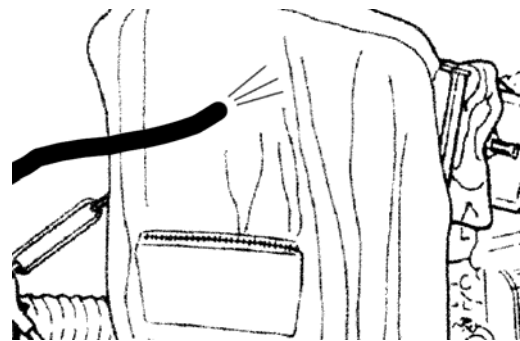

Next wash the outer filter bag from both sides (inside first and then outside).

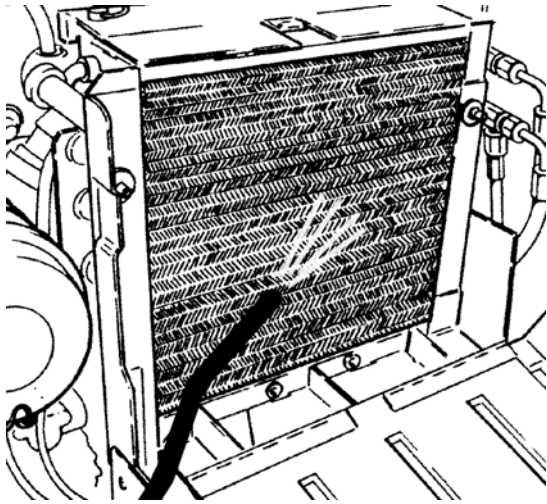

Wash the radiator area thoroughly.
Please pay particular attention to the corners of the radiator where more dirt collects.

⚡ If using a pressure washer then please avoid damaging the radiator cooling fins when holding the pressure washer nozzle too close to the radiator.

Wash the rest of the machine exterior such as the front suction nozzle, brushes and bodywork.

Try to avoid washing the control console directly.

Although they are waterproofed from rain etc., direct soaking with a hose may allow water to enter the machine electrical systems.

Instead, use a damp rag to clean off the control console.

For the Model 414RS only:

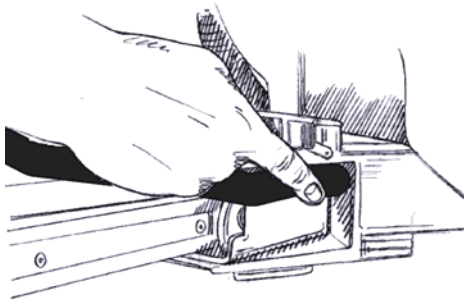

During the wash down, please leave the seat

extended and flush out the swivel box section as shown.
This helps the seat move in and out more easily.

Turn off the washing hose.

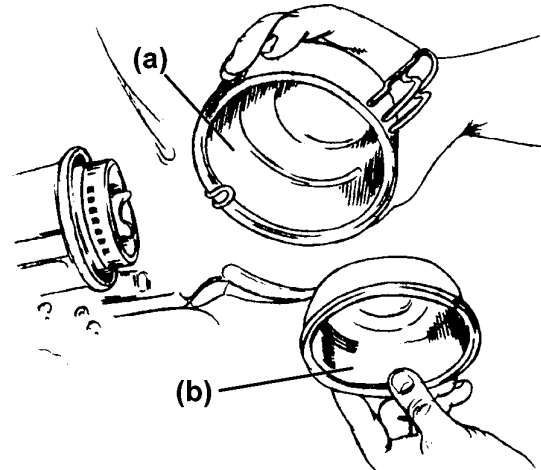

Remove the air filter end cap (a) and tap out dirt that has collected inside the cap and the inner collector (b). Wipe off the end cap and collector with a clean, dry rag.

Replace cap.

End of week wash down.

Your Green Machine should receive a more thorough “maintenance wash” from time to time to keep it in good condition.

We recommend once per week.

This will require stripping down and removing the side panel and front hose assembly to give the inside of the impeller housing and the engine and hydraulics areas a thorough clean.

⚡ **Ensure the starter keys are out.**

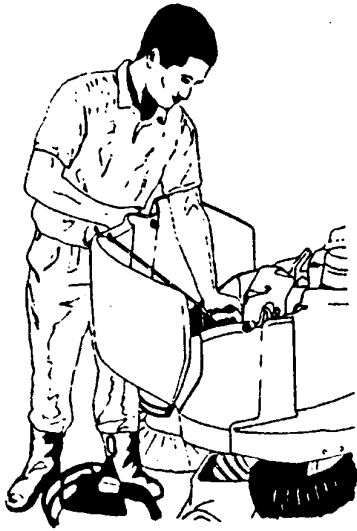

First remove the front box, or CSA/DEA (if fitted).

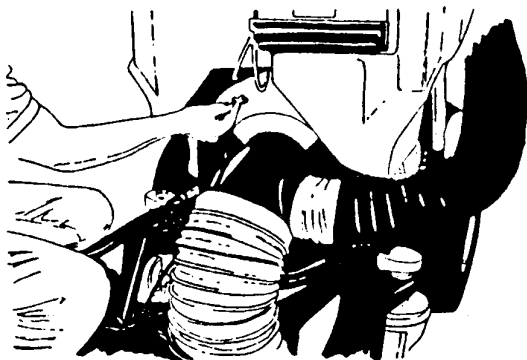

Remove the front suction hose assembly by unscrewing the six knobs on the fan casing access cover and unscrewing the single knob at the base of the suction hose.

Pull the bottom end of the hose away first, and then the top end.

Check that the impeller fan is free to turn, that it is not damaged, and that nothing is wrapped around the impeller.

⚡ **Never turn the impeller by hand unless you have first removed the starter keys!**

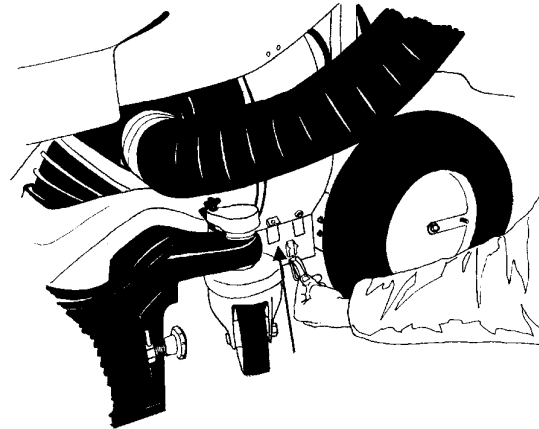

Open the sludge trap door.
Wash out the inside of the impeller fan housing.

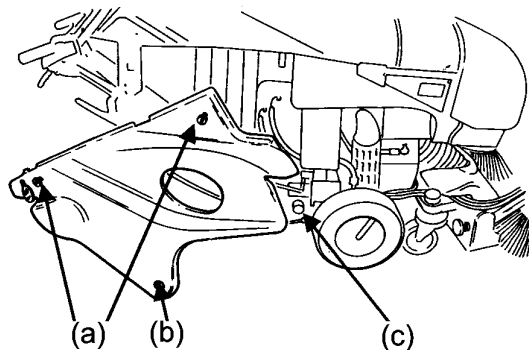

Next, remove the side panel by unscrewing the two retaining screws (a) and popping the rubber stopper (b) and (c).

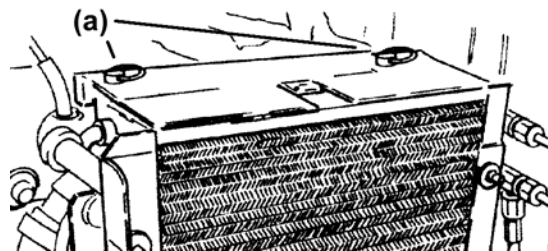

Lastly, remove the engine top cover by unfastening the two ring-head fasteners (a) and pulling the engine cover clear.

Wash down and around the engine and hydraulic block areas and anywhere there is a dirt build-up.

Reassemble.



Care of the filter bag.

The filter bag should be thoroughly washed inside and out each day. The bag is the lung of the machine and suction performance will be poor if it is not kept clean.

However over time, there can be an invisible build up of oils, tars and grease from debris picked up.

If you have thoroughly washed the filter bag, but suction performance is poor, it is possible that these oils etc. are causing the bag not to breathe properly.

You can tell if the bag is not breathing properly by revving the machine up, and pushing on the sides of the bag. If the bag feels like it is tight like a balloon, then the air is having

difficulty in getting out.

You should then remove the filter bag, and wash it in a washing machine.

Use a warm cycle, not a hot one (Too hot a wash can shrink the bag slightly and you will lose performance).

Use ordinary washing machine detergent.

⚡ **Do not use fabric conditioner – this can cause a loss of performance.**

After washing you can rub a candle to wax the zipper for smoother opening.

⚡ **Do not use oil or grease on the zipper – this will only cause dirt and dust to stick to it and will make the zipper difficult to use.**

Chapter 15

Fault Finding

This section covers some basic problems that you might encounter with your Green Machine and how you might solve them. For more advanced faultfinding please refer to the Green Machine shop manual.

The machine is not picking up or is leaving a trail.

The engine revs are set too low for the material being swept.

Increase the engine speed.

The machine is traveling too fast for the conditions.

Slow down to give the heavier debris time to get picked up by the airflow.

The inner plastic sack is full.

Fit a new inner trash bag.

The filter bag is clogged with dirt or is too wet.

If the filter bag feels tight like a balloon when the engine revs are increased, then the problem may be that the filter bag is not able to breathe.

If the filter bag is wet, then open the side zipper and sludge door as described in Chapter 8.

If the filter bag is dry, then it may be that there is a dust build-up on the surfaces of the bag.

Solution

Switch the engine off.

With the zipper closed, shake the sides of the filter bag to let dust drop away from the surface.

If this is not effective, then you will have to wash out the filter bag.

If you have washed and dried the filter bag, and it still feels tight like a balloon when you increase the engine revs, then the bag may be blocked with invisible oils or grease.

Please see the previous chapter for details of how to wash your filter bag in a washing machine.

Some possible causes of your filter bag becoming blocked quickly.

You may not be using the bag spray jet correctly or the jet may be blocked, or you may have run out of water.

Also remember not to run with too high engine revs when you start sweeping – this will blow dust out of the plastic trash bag and onto the filter bag surface.

You may be sweeping very heavy debris that is overwhelming the machine. Please try spacing yourself out from the heavy debris areas and taking “cuts” as described in Chapter 8 - Sweeping along buildings and curbs.

There may be a blockage in the front suction hose.

Please see Chapter 8 for details of how to unblock.



The front flap may be open when sweeping heavy material.

Close the flap – remember that there is less suction power for heavier debris when the flap is open.

The suction nozzle may be set too high off the ground.

Adjust down to the correct clearance – please see Chapter 3 for details of how to set the correct height.

The back trunking or filter screen may be restricted or blocked.

In dusty conditions, the filter screen that sits inside the plastic trash bag may get blocked.

⚡ **Switch off engine and remove keys.**

Remove the filter screen and shake it vigorously to un-stick dirt from the mesh.

Swing-open the back trunking to see if there is a blockage.

The machine pulls to one side or feels heavy to handle.

The parking brake may not be fully off.

Set and release the parking brake a few times. You should feel the brakes coming off as you release the brake lever.

The front castor wheels may not be working correctly.

The rubber seal around the castor top plate can sometimes jam and stop free movement. Remove the seal and discard or refit.

Ensure that the castor assemblies are greased.

The rear castor wheel may not be working correctly. (Model 414S2D only).

Check that the rear castor rotates clockwise and anticlockwise freely. Ensure that the castor is correctly greased.

The fold and stow seat unit may not be working correctly. (Model 414RS only).

If the seat unit is folded away in the walk-behind position, then check that the rear castor rotates clockwise and anticlockwise freely.

If the seat unit is out in the ride-behind position, then check that the castor is locked in position as described in chapter 9.

Also check that the seat is fully out in the locked position, and that the swivel box is free to move to the left and right easily.

The tires may be under-inflated.

Check all tire pressures – see Chapter 16 for the correct pressures.

The brushes bounce when sweeping.

The brush speed may be set too slow for the machine travel speed.

Increase the brush rotation speed.

The brush height may be set too low.

This is particularly true when using heavy-duty brushes. Decrease the pressure on the brushes by raising the brush height (see Chapter 3).



There may be excessive play in the brush arms.

Check that the brush arm assemblies have been greased thoroughly.
If greasing fails to cure the problem then you may need to replace the link arm bushings. (See Workshop manual).

The machine will not move forward or it drives slowly.

The parking brake may not be fully off.

Set and release the parking brake a few times. You should feel the brakes coming off as you release the brake lever.

The brush speed may be set too high.

The brushes have a priority over the drive system in receiving hydraulic power. Try to lower the brush rotation speed and see if this is effective.

There may be an item wrapped behind the impeller fan.

This may cause the engine to be unable to get up to speed and may also cause engine overheating or starting problems. Check the impeller is free to turn by hand and feel to see if any items such as tee shirts etc. are wrapped behind the impeller fan.

⚡ **Always remove starter keys before opening the impeller fan housing!**

The emergency brake release valve may not be fully closed or it may be damaged.

Check that the valve is tightened hand-tight. If it is fully closed, but you can still push or pull the machine forward or back slowly, then the valve may have been damaged by over-tightening it. Please see the shop manual for more details.

The CSA/DEA option may still be on.

The machine is designed not to drive when the CSA or DEA is running. Check the system is switched off.

The hydraulic system may be overheating or the hydraulic filter needs to be replaced.

This may cause you to lose drive. Please see that section later in this chapter.

The hydraulic oil level may be low.

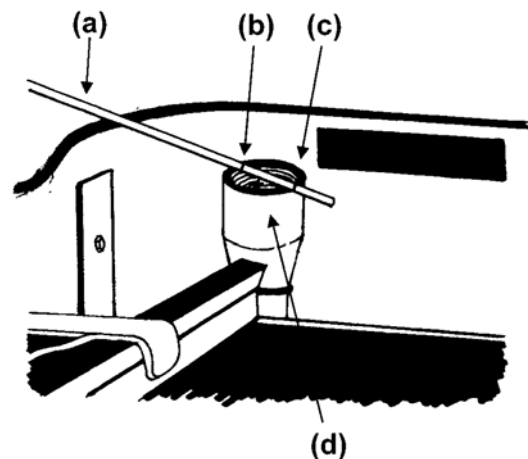

Check the oil level is between the maximum (b) and minimum (c) marks on the dipstick (a). Fill to the maximum level with regular 10W40 engine oil through the filler tube (d). If you need to refill the hydraulic oil frequently,



then you probably have a hydraulic oil leak. Inspect and repair.

There may be excessive wear in the hydraulic system.

If the drive is good when the brushes are switched off, but the drive gets much worse when the brushes are switched on, then you may have a hydraulic wear problem in either the brush motors or hydraulic pump. Please see the shop manual for more details.

If the drive is poor whether the brushes are on or off, then you may have a hydraulic wear problem in either the drive motor or hydraulic pump or you may have a problem in the hydraulic control block. Please see the shop manual for more details.

There may be a gearbox or axle problem.

Please see the shop manual for more details.

If your machine is equipped with the snowplow option...

The hydraulic lines that go to brushes have quick release couplings to allow the snowplow to be fitted.

If you notice a loss of drive when you turn on the brushes, then it may be that the quick release couplings are badly connected or are faulty. This will cause the hydraulic oil going to the brushes to have difficulty passing through the lines, and so you will experience a loss of drive.

If you have the snowplow fitted and you experience loss of drive in moderate snow conditions, please check that the brush control lever is fully closed. If it is not, then the machine will be trying to pump oil to the hydraulic lines for the brushes, which are of course blanked shut when the quick release couplings have been disconnected.

The engine appears to be overheating.

The coolant level may be too high.

As the engine warms up, the coolant expands and the liquid level in the expansion tank rises. If the system is overfilled, then coolant will be forced out of the pressure cap. Check that the level is as specified in chapter 4.

⚡ **Take care when opening the pressurized cap when the engine is hot. This is a pressurized system with very hot liquid inside.**

The radiator may be blocked with dirt or the radiator fins may be damaged.

Wash the radiator thoroughly as described in Chapter 14. Alternatively use a compressed airline to blow dirt out of the radiator.

You may have the incorrect coolant mixture.

Drain and refill the coolant with a fresh mixture of 50:50 water / anti-freeze. Too much antifreeze in the mixture can lead to loss of cooling efficiency. Too little anti-freeze can lead to corrosion and freezing problems.

There may be an item wrapped behind the impeller fan.

This may cause the engine to be working hard to overcome the resistance, and may cause engine overheating or starting problems. Check the impeller is free to turn by hand and feel to see if any items such as tee shirts etc. are wrapped behind the impeller fan.

⚡ **Always remove starter keys before opening the impeller fan housing!**



You may be using bad or contaminated diesel fuel.

Drain the fuel tank, change the fuel filter and refill the tank with diesel from another source. Please see the shop manual for more details.

The engine will not turn over.

The battery may be flat.

Check that the battery is fully charged and is connected properly. Check that the battery posts are corrosion free. Please see shop manual for more details.

The in-line starter fuse may have blown.

There is a 40 Amp fuse protecting the starter motor solenoid on the right side of the machine near the exhaust.

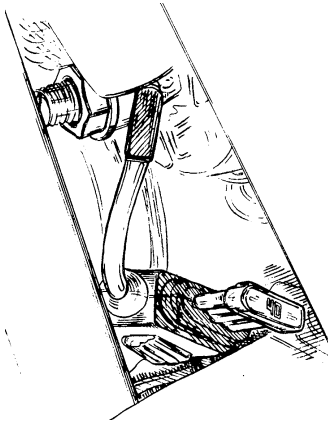

Check that it has not blown.

There may be an item wrapped behind the impeller fan.

The starter motor may be unable to overcome the resistance caused by an item jamming

the impeller.

Check the impeller is free to turn by hand and feel to see if any items such as tee shirts etc. are wrapped behind the impeller fan.

⚡ Always remove starter keys before opening the impeller fan housing!

The starter motor or starter switch may be faulty.

Please see the shop manual for more details.

The safety switches may not be making the correct contact or the rear trunking may not be fully closed

If your machine is equipped with the snowplow option...

The hydraulic lines that go to brushes have quick release couplings to allow the snowplow to be fitted.

If you have the snowplow fitted and you experience starting problems, then please check that the brush control lever is fully closed. If it is not, then the machine will be trying to pump oil to the hydraulic lines for the brushes, which are of course blanked shut when the quick release couplings have been disconnected or are not connected correctly.

The engine turns but will not start.

The engine pre-heater may not have been given long enough time.

In cold weather, the engine needs to be warmed to help it start. See Chapter 5 for the correct starting procedure.



The battery may not be fully charged.

Check that the battery is fully charged and is connected properly. Check that the battery posts are corrosion free. Please see shop manual for more details.

The emergency engine shut-off button may not be fully closed.

Please see Chapter 5 for more details.

There may be an item wrapped behind the impeller fan.

The starter motor may be unable to fully overcome the resistance, and may cause engine-starting problems.

Check the impeller is free to turn by hand and feel to see if any items such as tee shirts etc. are wrapped behind the impeller fan.

⚡ **Always remove starter keys before opening the impeller fan housing!**

You may be using bad or contaminated diesel fuel.

Drain the fuel tank, change the fuel filter and refill the tank with diesel from another source. Please see the shop manual for more details.

The charging light fails to go out after the engine is started.

The engine fan belt may be loose or broken.

Please see the shop manual for more details.

The engine alternator or charging regulator may be faulty.

Please see the shop manual for more details.

The engine is smoking.

Some causes of engine smoking can be rectified easily and with no damage to the engine if cured quickly after the symptoms arise.

Attention should be paid to the color of the smoke.

Black smoke

Indicates that there is an incorrect fuel/air mixture in the engine. This is usually resolved easily with little potential damage to the engine if rectified promptly.

The air filter may be restricted.

Check the air filter minder that is located between the air filter housing and the engine.

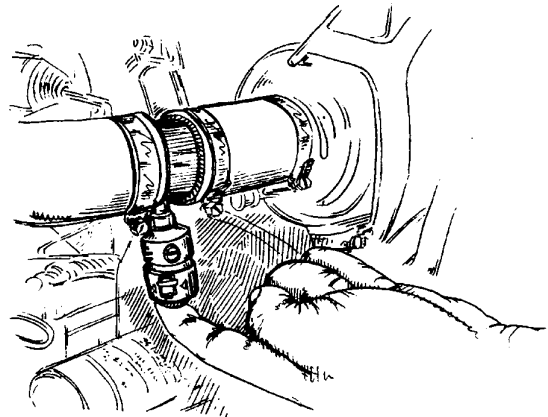

Push the reset button on the filter minder while the engine is running. If the red indicator is showing through the window on the filter minder, then there is a restriction in the air filter system.

Check that the air filter inlet screen which sits at the bottom of the air filter housing is not clogged. The metal mesh can become clogged with dirt. This can be because diesel fuel has spilled onto the screen when



the machine was being refueled, and dirt has stuck to the screen.

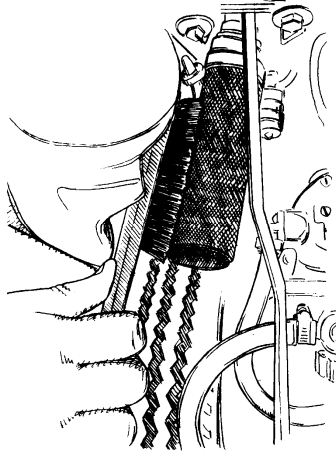

Clean the screen with a wire brush. If the air filter minder still shows a restriction, then replace the air filter element.

You may be using bad or contaminated diesel fuel.

Drain the fuel tank, change the fuel filter and refill the tank with diesel from another source. Please see the shop manual for more details.

The fuel injectors may be worn or damaged. Please see the shop manual for more details.

Bluish or gray smoke

Indicates that the engine is burning oil through wear or damage. Please refer to the shop manual for more details.

White smoke

The fuel injectors may be worn or damaged. Please see the shop manual for more details. In extreme cases where the injectors are sticking, then a loud banging noise and poor running may accompany the smoke.

The cylinder-head gasket may be leaking. The engine may have been subject to severe overheating and the cylinder head gasket has failed. Please see the shop manual for more details.

The hydraulic system is overheating.

The hydraulic oil level may be low.

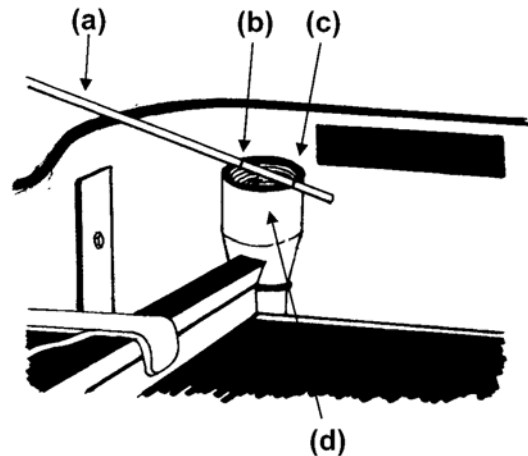

Check the oil level is between the maximum (b) and minimum (c) marks on the dipstick (a). Fill to the maximum level with regular 10W40 engine oil through the filler tube (d). If you need to refill the hydraulic oil frequently, then you probably have a hydraulic oil leak. Inspect and repair.

The hydraulic filter may need replacing.

Please see the shop manual for more details.

The radiator may be blocked with dirt or the radiator fins may be damaged.

Wash the radiator thoroughly as described in Chapter 14. Alternatively use a compressed airline to blow dirt out of the radiator.

The water system is not working.



There may be no water in the tank.

Check level and refill.

The spray jets may be blocked.

Remove the filter assembly by twisting the bayonet fitting.

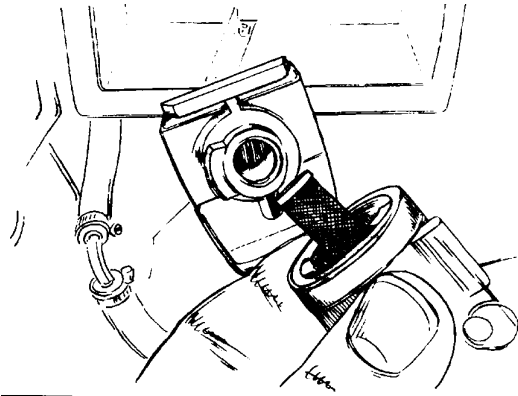

Check the filter behind the spray is clear. Rinse in water.

Disassemble the spray jet assembly by pushing the spray jet out past the rubber sealing-ring.

For the brush spray jets either blow clean with compressed air, or rinse in hot water.

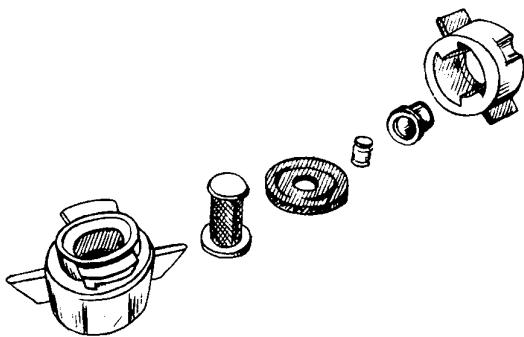

For the bag spray jet, the dark-blue colored center core pops out from the outer light-blue colored spray jet body. Use a flat-blade screwdriver or your thumbnail to disassemble the two pieces. Then blow out with compressed air or rinse in hot water.

⚡ **Do not poke wire or other objects through the small spray nozzle openings. This may damage the spray jet.**

The water tank outlet may be disconnected or blocked.

Make sure that the quick release hose coupling on the tank drain cap is securely fitted.

Remove the drain cap assembly and clean the filter screen with compressed air or rinse it.

The water pump fuse may have blown.

Check to see if the water pump is powered up. If not, then check that the fuse in the control console is good.

The fold and stow seat will not pull out or stow.

The locking mechanism may not have released.

Try to move the locking lever several times while pulling and pushing on the grab handle at the rear of the machine. (Remember: push lock in to pull seat out)

The slide and roller mechanism might be packed with dirt.

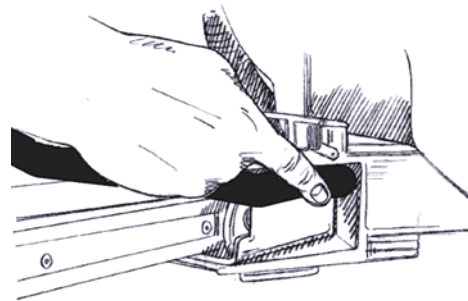

If the seat is in the out position, move the seat unit to the side and wash out the area shown above.

If the seat unit is in the stowed position, you will have to get it out by tapping the foot pedals with a mallet or hammer and block of wood. Then wash out the area shown above.



There is an electrical problem.

Check the main fuse box. The fuse box door is located at the front of the operator console.

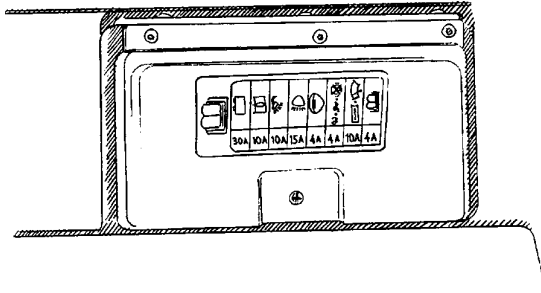

Open the door using a small screwdriver to release the lower screw.

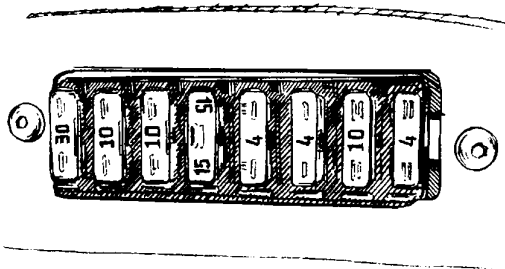

Check the fuses are intact by removing each in turn and viewing the fuse blade. If it is broken or the fuse is discolored, then replace with the same value fuse.

 **Always replace with the correct value fuse to avoid damage to your machine.**

In addition to the fuses located in the fuse box, there is also a 40 Amp fuse protecting the starter motor solenoid on the right side of the machine near the exhaust.

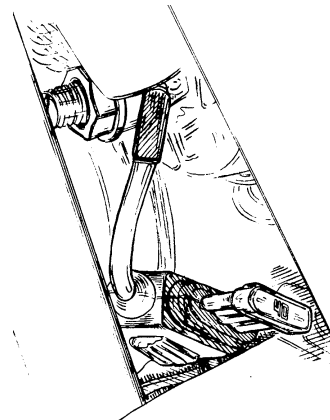

Remove the rubber cap and check that the fuse has not blown.

Chapter 16

General specifications

Overall dimensions:

Height:	414.....1143mm (45")
Height – no cab:	424.....1397mm (55")
Height – with cab:	424.....1854mm (73")
Length (Walk-behind):	All2515mm (99")
Length (Ride-behind):	414RS.....2997mm (118")
	424.....3530mm (139")
Swept width:	All1170mm (46")
Wet weight:	414S2D.....420 kg. (926 lbs.)
	414RS.....460 kg. (1015 lbs.)
	424TR508 kg. (1120 lbs.)
	424HS.....520 kg. (1150 lbs.)

Maximum forward speed:

414S2D, 414RS, 424TR:	8.8 km/h (5.5mph)
424HS:	16 km/h
(10 mph)	
Reverse speed:	5.6km/h
(3.5mph)	

Engine: Kubota Z482e twin cylinder liquid-cooled diesel.

Maximum revolutions:2800 r.p.m.
Maximum power:12 b.h.p. (9kw)
Engine Capacity: 479 cc
Engine oil Capacity:2.2lts (2.3 Qrts)
Engine Oil Specification: 10w/40
(Oil should conform to American Petroleum Institute (API) grade CF or better).	
Coolant:	50%/50% water/glycol-based anti-freeze mix
Diesel fuel Specification:	ASTMd975 cetane no4 (min.)
Diesel capacity:	9.4
litres (2.5 U.S. gal)	

Electrical

12 volt negative earth. 18 amp charging circuit.
40 ampere / hour battery.
Lighting front and rear.
Flashing warning beacon(s).
Audible Warning system.

Water system:

55 litre (14.5 US gallon) water tank with filtered outlet.
12-volt electric pump for dust suppression.
Inner bag atomized spray (1).
Brush fan jet spray (2).
Two control valves for spray jets.

Tire pressures:

Main Road Tires:	3.2 bar (47 psi)
Rear Tires:	3.5 bar (51 psi)

Curb climbing height:

Maximum:	100 mm (4")
----------	-------------

Noise levels:

Sound Pressure at Operator's ear:
81 dB (A) Leq at 2,800 rpm at operator's ear.
O.S.H.A regulations stipulate maximum level of 85 dB (A) Leq for an 8 hour work day.
Environmental Noise Level:
68.1 dB(A) at 2,600 rpm at 10 m (33 feet)

Hydraulics:

Hydraulic tank capacity: 6.5litre(1.7 US gal)
Oil type:
Same as engine oil, i.e. 10w/40 multi-grade to API CF specifications.
Maximum system pressure: 193 bar (2,800 psi)

Inclination:

Maximum inclination clockwise or anti clockwise:
30 deg from perpendicular



Vibration:







**Complies with standard PrEN 1033, ISO 8662.
Vibration limits are below 2.5 ms².**

Advisory and caution labels





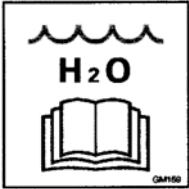

The explanations for the meaning of all advisory and caution labels affixed to the machine are given below.

Advisory labels are recommendations and are shown as yellow colored labels.

 **Caution labels are shown inside blue-colored circular fields and the instructions given in this book must be adhered to so as to avoid risks of personal injury or death.**

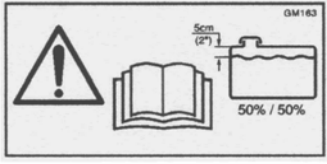
	<p>Operator Manual.</p> <p>All operators must be properly trained and must read and follow the instructions in this manual prior to operating the machine.</p>
	<p>Throttle Control.</p> <p>Adjusts the engine speed from idle to maximum.</p>
	<p>Brush Speed Control.</p> <p>Adjusts the brush speed from 0 to 100 revs per minute.</p>
	<p>Water Spray Control.</p> <p>Left Valve: controls brush spray jets. Right Valve: controls filter bag spray jet.</p>
	<p>Water Supply.</p> <p>Refer to operator manual for correct use of disinfectants or chemicals.</p>
	<p>Water Drain Cap.</p> <p>Arrow indicates the location of the water tank drain cap.</p>



	<p>Diesel.</p> <p>Fill fuel tank with diesel fuel only.</p>
	<p>Engine Oil.</p> <p>Refer to operator manual for correct specification of engine oil.</p>
	<p>Engine Coolant.</p> <p>Use 50% water / 50% glycol-based antifreeze. Fill to a level 5 cm (2") below top of header tank as described in operator manual.</p>
	<p>Engine Radiator Cap.</p> <p>⚠ Caution: This container may be pressurized to 0.9 bar and contains liquid which may be very hot.</p> <p>To Open: Turn cap anticlockwise with care. To Close: Turn cap clockwise.</p>
	<p>Hydraulic Oil.</p> <p>Refer to operator manual for correct specification of hydraulic oil.</p>
	<p>Hydraulic Oil Filter.</p> <p>Refer to workshop manual before removing or replacing the filter.</p>
	<p>Radiator / Oil Cooler Cleaning.</p> <p>The radiator / oil cooler assembly must be washed at least every 24 hours as instructed in the operator manual.</p>



	<p>Do not wash machine when engine is running.</p> <p>Do not allow water to enter the air filter housing, and do not wash the machine with the engine running. Refer to operator manual for instructions on air filter maintenance.</p>																								
	<p>Fan Casing Access Cover / Impeller Fan Warning.</p> <p>⚡ Danger of injury. Moving parts inside. The engine must be switched off and the starter keys removed before opening the fan casing access cover.</p>																								
	<p>Fan Casing Trunking / Impeller Fan Warning.</p> <p>⚡ Danger of injury. Moving parts inside. The engine must be switched off and the starter keys removed before opening the back trunking.</p>																								
	<p>Fan Casing Sludge Door / Impeller Fan Warning.</p> <p>⚡ Danger of injury. Moving parts inside. The engine must be switched off and the starter keys removed before opening the sludge door.</p>																								
	<p>Machine Wash Down.</p> <p>The machine should be washed at least once every 24 hours as instructed in the operator manual.</p>																								
<table border="1" data-bbox="321 1543 446 1795"> <tr> <td></td> <td></td> <td></td> </tr> <tr> <td>4A</td> <td></td> <td></td> </tr> <tr> <td>10A</td> <td></td> <td></td> </tr> <tr> <td>4A</td> <td></td> <td></td> </tr> <tr> <td>10A</td> <td></td> <td></td> </tr> <tr> <td>4A</td> <td></td> <td></td> </tr> <tr> <td>4A</td> <td></td> <td></td> </tr> <tr> <td>30A</td> <td></td> <td></td> </tr> </table>				4A			10A			4A			10A			4A			4A			30A			<p>Fuse Identification.</p> <p>Refer to operator manual for more details.</p> <ul style="list-style-type: none"> • Hour meter and engine stop solenoid. • Oil pressure warning light. • Water Pump for dust control. • Beacon and horn/voice message. • Lights. • Refer to operator manual. • Reverse system control (where fitted). • Main electrical feed.
4A																									
10A																									
4A																									
10A																									
4A																									
4A																									
30A																									

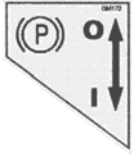

Parking Brake.

Parking brake on - down position.

Parking brake off - up position.



Chassis Identification Plate

Applied Sawsports LTD. Barrhead Park, Scotland FK2 7XE Tel. 01324 811888		
MODEL	414S2D	
CHASSIS		
ENGINE		
C.I.N.		
POWER AT 2800 RPM	9 kW	12 HP
	WEIGHT	
	400 Kg	
	882 LBS	
CE		

Applied Sawsports LTD. Barrhead Park, Scotland FK2 7XE Tel. 01324 811888		
MODEL	414RS	
CHASSIS		
ENGINE		
C.I.N.		
POWER AT 2800 RPM	9 kW	12 HP
	WEIGHT	
	440 Kg	
	970 LBS	
CE		

Description

MODEL –	414 S2D	walk-behind only model.
	414RS	fold-and stow seat model.
	424TR	twin wheeled rear seat model.
	424HS	high-speed model.

CHASSIS – The chassis number is a six-figure number, which gives the month and year of manufacture and an individual machine serial number. When specifying the year, only the last number of that year is indicated.

Example: 2 05 623 was built in May (5th month) of 2002.

Year / Month | Serial No.

ENGINE – Denotes the engine serial number as supplied by the engine manufacturer.

CIN – Is the Change Identification Number, which denotes the build modification standard of the machine at the time of production.

Power at 2800 rpm – Is the power developed by the engine as specified by the engine manufacturer.

Weight – Denotes the standing weight of the machine (empty) and is specified in Kilograms and Pounds.